

ADJUSTMENT PROCEDURE

INTRODUCTION

IMPORTANT—PLEASE READ BEFORE USING THIS PROCEDURE

The “Adjustment Procedure” is used to restore optimum performance or return the instrument to conformance with its “Performance Requirements” as listed in the “Specification” (Section 1). As a general rule, these adjustments should be performed every 2000 hours of operation or once a year if used infrequently.

PARTIAL PROCEDURES

This procedure is divided into subsections to permit calibration of individual sections of the instrument whenever complete instrument calibration is not required. To perform a partial procedure, first set the instrument as directed in the Initial Setup Conditions at the beginning of the section, then make any changes called for within the procedure. Perform all steps within a subsection, both in the sequence presented and in their entirety to ensure that control settings will be correct for the following steps.

The adjustments in CAL 01, 02, 03, and 04 should be performed in numerical sequence, i.e., CAL 01 should be done before CAL 02, CAL 02 should be done before CAL 03, etc. Performing partial procedures when setting the automatic calibration constants (i.e. only one or two of the CAL steps) is not recommended and should only be done if the calibration constants set in the preceding steps are known to be correct.

BEFORE YOU BEGIN:

NOTE

When performing any of the automatic calibration routines (CAL 01 through CAL 04), the CAL/NO CAL jumper P501 must be moved to its CAL position (between pins 1 and 2) before turning the power on. When the desired calibration has been performed, return the jumper to its NO CAL position.

- a. Turn instrument Power on.

NOTE

The instrument MUST have a 20-minute warmup period before making any adjustments. Performing the adjustment procedure while the temperature is drifting may cause erroneous calibration settings.

POWER SUPPLIES

Equipment Required (see Table 4-1)

Oscilloscope With 10X P6131 Probe (Item 6)
Digital Multimeter (Item 18)

Alignment Tool (Item 19)
1X Probe (Item 20)

See **ADJUSTMENT LOCATIONS 1** and **ADJUSTMENT LOCATIONS 4**

at the rear of this manual for test point and adjustment locations.

NOTE

If the instrument displays "DIAGNOSTIC. PUSH A/B TRIG TO EXIT" at power on, one of the power-up tests has failed. If the error message on the bottom line of the display is "TEST 04 FAIL xx" where "xx" is 01, 10 or 11, stored calibration data is in error, and the instrument should be recalibrated. If this is the case, pressing the A/B TRIG button will force entry to the normal operating mode; however, the accuracy of any measurement taken could be in error.

If any other error message occurs, the failure is probably not related to calibration. In this case, the instrument should be repaired before attempting calibration.

Initial Control Settings.

Controls settings not listed will not affect the procedure.

VERTICAL VOLTS/DIV	
CH 2	0.1 V
CH 3 and CH 4	0.1 V (buttons out)
CH 1 and CH 2 VAR	In detent
Input Coupling	
CH 1 and CH 2	1 M Ω DC
VERTICAL MODE	
CH 1	On (button in)
CH 2, CH 3, and CH 4	Off (buttons out)
ADD, INVERT, and	
BW LIMIT	Off (buttons out)
ALT/CHOP	ALT (button out)
VERTICAL POSITION	Midrange
A and B SEC/DIV	X-Y (knobs locked)

A and B SEC/DIV VAR	In detent
Horizontal POSITION	Midrange
TRIGGER	
MODE	AUTO LVL
SOURCE	VERT
COUPLING	DC
SLOPE	+ (plus)
LEVEL	Midrange
HOLDOFF	In detent
ΔV and Δt	Off (press and release until readout display disappears)
INTENSITY	Visible display
READOUT INTENSITY	Visible display (CCW from MIN)
SCALE ILLUM	Fully CCW
FOCUS	Defocused dot

1. Check/Adjust Power Supply DC Levels, Regulation, and Ripple (R1292).

a. Connect the Digital Multimeter (DMM) negative lead to chassis ground. Connect the positive lead to the first test point listed in Table 5-1 (all test points are on the Main Board).

b. CHECK—That the reading is within the limits given in Table 5-1.

c. ADJUST—Volt Ref Adj (R1292) for a DMM reading of precisely 10.00 V. The adjustment is accessible through a hole in the top cover plate.

Table 5-1
Power Supply Voltage and Ripple Tolerances

Power Supply	Test Point (+ Lead)	Reading	Total p-p Ripple	p-p Ripple at Two Times Line Frequency
+10 V	J119-4	+ 9.99 to +10.01	100 mV	1 mV
+87 V	J119-8	+85.26 to +88.74	80 mV	5 mV
+42.4 V	J119-9	+41.55 to +43.25	80 mV	2 mV
+15 V	J119-6	+14.775 to +15.225	15 mV	11mV
Digital +5 V	J119-2	+4.85 to +5.15	150 mV	30 mV
Analog +5 V	J119-12	+4.925 to +5.075	15 mV	1 mV
-5 V	J119-5	-4.965 to -5.035	15 mV	1 mV
-8 V	J119-11	-7.88 to -8.12	100 mV	1 mV
-15 V	J119-1	-14.775 to -15.225	10 mV	2 mV

d. Repeat parts a and b for the other test points listed in Table 5-1.

g. Using a 1X probe, connect the test oscilloscope probe ground lead to chassis ground. Connect the probe tip to the first test point listed in Table 5-1.

e. Disconnect the DMM.

f. Set the test oscilloscope as follows:

Sweep Speed	5 ms/div
Input Coupling CH 1	1 M Ω AC
Vertical controls	To display CH 1
Trigger controls	Line source, triggered display
Volts/Division	2 mV
BW Limit	20 MHz (button in)

h. CHECK—Ripple at two times the line frequency and the total peak-to-peak ripple do not exceed the values given in Table 5-1.

i. Repeat part h for each test point in Table 5-1.

j. Disconnect the test oscilloscope.

CRT ADJUSTMENTS

Equipment Required (see Table 4-1)

Primary Leveled Sine-Wave Generator (Item 2)	50 Ω BNC Cable (2 required) (Item 9)
Time-Mark Generator (Item 5)	Alignment Tool (Item 19)

See  ADJUSTMENT LOCATIONS 2

at the rear of this manual for location of adjustments and test points.

NOTE

All crt adjustments (other than the Front-Panel ASTIG, FOCUS, and TRACE ROTATION adjustments) are accessed through the High Voltage shield located on the left side of the instrument near the rear of the crt. The location of each adjustment is indicated on the shield.

TRACKING/INDEP	INDEP (button out)
INTENSITY	Visible display
READOUT INTENSITY	Scale factors off (CCW from MIN)
SCALE ILLUM	Fully CCW
FOCUS	Best focused display

Initial Control Settings.

Control settings not listed do not affect the procedure.

VERTICAL VOLTS/DIV	
CH 1 and CH 2	0.1 V
CH 1 and CH 2 VAR	In detent
Input Coupling	
CH 1 and CH 2	1 MΩ GND
VERTICAL MODE	
CH 2 and BW LIMIT	On (buttons in)
CH 1, CH 3, and CH 4	Off (buttons out)
ADD and INVERT	Off (buttons out)
ALT/CHOP	ALT (button out)
VERTICAL POSITION	
A and B SEC/DIV	Midrange
A and B SEC/DIV VAR	X-Y (knobs locked)
Horizontal POSITION	In detent
TRIGGER	
MODE	AUTO LVL
SOURCE	VERT
COUPLING	DC
SLOPE	+ (plus)
LEVEL	Midrange
HOLDOFF	In detent
ΔV and Δt	Off (press and release until readout display disappears)

1. Adjust ASTIG Preset (R977) and Grid Bias (R1878).

- a. Position the dot in the center area of the graticule using the CH 1 and CH 2 POSITION controls.
- b. Focus the displayed dot as well as possible using the front-panel FOCUS control.
- c. ADJUST—ASTIG (R977 on the front panel), in conjunction with the FOCUS control, for the sharpest possible dot.
- d. Set the INTENSITY control knob CCW so the index mark points directly left (less than full CCW rotation).
- e. ADJUST—Grid Bias (R1878) for a barely visible dot.
- f. CHECK—No dot is visible when the INTENSITY control is rotated fully CCW.
- g. If necessary, repeat parts d and e until the CHECK in part f is correct.

2. Adjust TRACE ROTATION (R975) and Y-Axis Alignment (R1848).

NOTE

If the previous step was not performed, first setup the Initial Control Settings at the beginning of the CRT adjustments, then proceed as follows.

a. Set:

A and B SEC/DIV	50 μ s (knobs locked)
INTENSITY	As required for a well defined trace
Δ t	(Δ t readout)
INTENSITY	As required for well defined vertical cursors

b. Using the CH 2 Vertical POSITION control, align the trace with the center horizontal graticule line.

c. Position one of the Δ t cursors to the center vertical graticule line using either the Δ or the Δ REF OR DLY POS control.

d. ADJUST—TRACE ROTATION (R975 on the front panel) to align the trace with the center horizontal graticule line.

e. ADJUST—Y-Axis Alignment (R1848) to align the Δ t cursor with the center vertical graticule line.

f. Repeat parts d and e as necessary for the best aligned display.

3. Adjust Geometry (R1870).

NOTE

If the previous step was not performed, first setup the Initial Control Settings at the beginning of the CRT adjustments, then proceed as follows.

a. Set:

Input Coupling CH 2	50 Ω DC
Δ V and Δ t	Off (no readout)

b. Connect 10 μ s time markers from the Time-Mark Generator to the CH 2 input connector via a 50 Ω BNC cable.

c. Use the Horizontal POSITION control to align the time markers with the vertical graticule lines. Use the CH 2 POSITION control to align the base of the signal with the bottom graticule line.

d. Set the CH 2 VOLTS/DIV switch for at least a 6-division vertical display.

e. Use the CH 2 POSITION control to set the tops of the time markers to graticule center.

f. Set the CH 2 VOLTS/DIV switch one position clockwise to overscan the display.

g. ADJUST—Geometry (R1870) for minimum curvature of the time markers across the entire graticule.

h. Disconnect the test setup.

4. Adjust Edge Focus (R1864).

NOTE

If the previous step was not performed, first setup the Initial Control Settings at the beginning of the CRT adjustments, then proceed as follows.

a. Set:

Input Coupling CH 2	50 Ω DC
VOLTS/DIV CH 2	0.2 V
INTENSITY	Midrange

b. Connect a 50 kHz, 8-division signal from the Primary Leveled Sine-Wave Generator to the CH 2 input connector via a 50 Ω BNC cable.

c. Center the display on the graticule.

d. ADJUST—Edge Focus (R1864), FOCUS (front-panel control), and ASTIG (R977, front-panel preset) for the most uniform focus over the entire display.

e. Disconnect the test setup.

Adjustment Procedure—2445 Service

5. Adjust Z-Axis Transient Response (R1834).

NOTE

If the previous step was not performed, first setup the Initial Control Settings at the beginning of the CRT adjustments, then proceed as follows.

- a. Set:
- | | |
|------------------------|-------------------------|
| A and B SEC/DIV | 50 ns (knobs locked) |
| Input Coupling
CH 2 | 1 M Ω GND |
| INTENSITY | Slightly left of center |

b. Use the Horizontal POSITION control to place the beginning of the trace within the graticule.

c. ADJUST—Z-Axis Transient Response (R1834) for the most uniform intensity across the first division of display.

6. Adjust High Drive Focus (R1842).

NOTE

If the previous step was not performed, first set up the Initial Control Settings at the beginning of the CRT adjustments, then proceed as follows.

The following adjustment has the most effect on the first two divisions of the trace which will probably cause the readout to be compromised slightly. This will not be a problem as the readout is not used at full intensity.

- a. Set:
- | | |
|------------------------|--------------------------|
| ΔV | On (ΔV readout) |
| VOLTS/DIV
CH2 | 0.2 V |
| Input Coupling
CH 2 | 50 Ω DC |
| A and B SEC/DIV | 200 ns (knobs locked) |
| READOUT INTENSITY | Fully CW |
| INTENSITY | Fully CW |

b. Connect a 10 MHz, 6-division signal from the Primary Leveled Sine-Wave Generator to the CH 2 input connector via a 50 Ω BNC cable.

c. Center the display on the graticule.

d. ADJUST-High Drive Focus (R1842) for the best overall focus of the trace and readout.

e. Disconnect the test setup.

DAC REF, CH 1 AND CH 2 INPUT CAPACITANCE, AND VERTICAL READOUT JITTER ADJUSTMENTS

Equipment Required (see Table 4-1)

Calibration Generator (Item 3)	Digital Multimeter (DMM) (Item 18)
50 Ω BNC Cable (Item 9)	Alignment Tool (Item 19)
50 Ω Termination (Item 11)	Normalizer (Item 21)

See **ADJUSTMENT LOCATIONS 3** and **ADJUSTMENT LOCATIONS 4**

at the rear of this manual for test point and adjustment locations.

Initial Control Settings.

Control settings not listed do not affect the procedure.

VERTICAL VOLTS/DIV CH 1 and CH 2 CH 1 and CH 2 VAR Input Coupling CH 1 and CH 2 VERTICAL MODE CH 1 CH 2, CH 3, and CH 4 ADD, INVERT, and BW LIMIT ALT/CHOP VERTICAL POSITION A and B SEC/DIV A and B SEC/DIV VAR Horizontal POSITION TRIGGER MODE SOURCE COUPLING SLOPE LEVEL HOLDOFF Δt TRACKING/INDEP INTENSITY READOUT INTENSITY SCALE ILLUM FOCUS	0.1 V In detent 1 MΩ DC On (buttons in) Off (buttons out) Off (buttons out) ALT (button out) Midrange 0.1 ms (knobs locked) In detent Midrange AUTO LVL VERT DC + (plus) Midrange In detent On (Δt readout) INDEP (button out) Left of center As required for a visible display Fully CCW Best focused display
--	---

NOTE

The objective of this step is to make the total range of the DAC output voltage (sum of the CCW and CW readings) equal to 2.5 V.

a. Connect the digital multimeter (DMM) negative lead to the chassis ground. Connect the positive lead to pin 2 of J118 (on the Main Board).

b. Set the DMM to measure approximately 1.5 Vdc.

c. Rotate the ΔREF OR DLY POS control CCW until the DMM reading remains at a constant value (approximately -1.250 V). Note the reading.

d. Rotate the ΔREF OR DLY POS control CW until the DMM reading remains at a constant value (approximately +1.250 V). Note the reading.

e. Add the absolute values of the readings noted in parts c and d together (approximately 2.500 V).

f. Subtract the total in part e from 2.500 V, then divide the difference by two.

g. ADJUST—DAC Ref (R2127 on the Control Board) to add the (signed) number obtained in part f to the reading obtained in part d.

Adjustment Procedure—2445 Service

h. Repeat parts c through g as necessary to obtain a total DAC range of 2.500 V.

2. Adjust CH 1 and CH 2 Input Capacitance (C105 and C205).

NOTE

If the previous step was not performed, first setup the Initial Control Settings before the DAC Ref adjustment, then proceed as follows.

The objective of this adjustment is to match the input capacitance of the 50 mV per division position of the VOLTS/DIV switches to the 0.1 V per division position. The front corner of an input square-wave signal is used to indicate when the capacitances are matched

a. Connect a 1 KHz square-wave signal from the Calibration Generator high-amplitude output to the CH 1 OR X input connector via a 50 Ω BNC cable, a 50 Ω termination, and a normalizer. Adjust the generator output level for a 6-division signal vertically centered on the graticule.

b. Set the normalizer for a square front corner over approximately the first 40 μ s (0.4 division) of the positive portion of the waveform.

c. Change the CH 1 VOLTS/DIV switch to the 50 mV position and adjust the generator for a 6-division signal display.

d. ADJUST—The CH 1 50 mV C Adj (C105 on the Main Board) for the same waveform front corner noted in part b.

e. Repeat parts b through d until no change is observed in the waveform front corner when the CH 1 VOLTS/DIV switch is alternated between the 50 mV and 0.1 V positions. When switching between positions, reestablish the reference display amplitude at each position, and observe the square-wave front corner to make the comparison.

f. Move the input signal to CH 2 and change the VERTICAL MODE to display CH 2 only. Adjust the generator amplitude for a 6-division signal amplitude.

g. Set the normalizer for a square front corner over approximately the first 40 μ s (0.4 division) of the positive portion of the waveform.

h. Change the CH 2 VOLTS/DIV switch to the 50 mV position and adjust the generator for a 6-division display.

i. ADJUST—The CH 2, 50 mV C Adj (C205 on the Main Board) for the same waveform front corner noted in part g.

j. Repeat parts g through i until no change is observed in the waveform front corner when the CH 2 VOLTS/DIV switch is alternated between the 50 mV and 0.1 V positions. When switching between positions, reestablish the reference signal amplitude at each position, and observe the square-wave front corner to make the comparison.

k. Disconnect the test setup.

3. Adjust Vertical Readout Jitter (R618).

NOTE

If the previous step was not performed, first setup the Initial Control Settings before the DAC Ref adjustment, then proceed as follows.

a. Set the CH 1 Input Coupling to 50 Ω DC.

b. Press and release the Δ V button to obtain a Δ V display.

c. Use the Δ REF OR DLY POS control to position one cursor 3 divisions above graticule center. Use the Δ control to position the other cursor 3 divisions below graticule center.

d. Connect a 1 kHz, fast-rise signal from the Calibration Generator to the CH 1 OR X input connector via a 50 Ω BNC cable.

e. Set the generator output level for an 8-division display.

f. Use the CH 1 Vertical and Horizontal POSITION controls to center the CH 1 display on the graticule.

g. ADJUST—Vertical Readout Jitter (R618) for minimum vertical jitter of the readout characters and cursors.

h. Disconnect the test setup.

AUTOMATIC CALIBRATION CONSTANTS, HORIZONTAL AND VERTICAL GAIN, CENTERING, AND TRANSIENT RESPONSE ADJUSTMENTS

NOTE

Within the following procedure, the calibration constants for timing, vertical gain, and trigger level are generated by the system microprocessor and are stored in nonvolatile memory. The adjustments in CAL 01, 02, 03, and 04 should be performed in numerical sequence, i.e., CAL 01 should be done before CAL 02, CAL 02 should be done before CAL 03, etc. Performing partial procedures (i.e. only one or two of the CAL steps) is not recommended and should only be done if the calibration constants that would have been set in the preceding steps are known to be correct.

The CAL functions are available only if the CAL/NO CAL jumper (P501 on the Control Board) is in the CAL position (between pins 1 and 2) when power is turned on. When the automatic calibration procedures are completed, return the jumper to the NO CAL position to prevent entry into the calibration routines.

Equipment Required (see Table 4-1)	
Calibration Generator (Item 3)	Dual-Input Coupler (Item 10)
Time-Mark Generator (Item 5)	5X Attenuator (Item 16)
50 Ω BNC Cable (Item 9)	Digital Multimeter (DMM) (Item 18)
	Alignment Tool (Item 19)

See **ADJUSTMENT LOCATIONS 4**

at the rear of this manual for test point and adjustment locations.

Initial Control Settings.

CAL/NO CAL jumper CAL position (between pins 1 and 2) prior to turning on power

b. CHECK—Top line of the readout display says: "DIAGNSTIC. PUSH A/B TRIG TO EXIT".

NOTE

When performing the automatic CAL steps, initial setting of the front-panel controls is not required.

NOTE

The "menu" of calibration, test, and exercise routines are in a loop that may be scrolled through in single steps, either forward or backward. Pressing up or down on the TRIGGER MODE switch and releasing it respectively increments or decrements the menu position by one. As each routine is selected, its name appears in the lower left corner of the readout display.

CAL 01—HORIZONTAL

1. Check/Adjust Horizontal Timing, X1 Gain (R860), X10 Gain (R850), Hrз Ctr (R801), and Trans Resp (R802).

a. Simultaneously press in and hold the Δt and the ΔV push buttons, then press and hold the SLOPE switch. Hold all three switches in for approximately one second, then release them.

When performing a calibration step, touch only the specific control or controls called out in the procedure. Movement of other controls may cause erroneous calibration results.

c. Scroll to CAL 01.

Adjustment Procedure—2445 Service



Upon entering CAL 01, the Input Coupling is automatically set to 50 Ω DC and the 50 Ω OVERLOAD protection is disabled. Before starting the procedure, make sure any 50 Ω OVERLOAD condition has been cleared.

NOTE

In this procedure, pressing up and releasing the TRIGGER COUPLING switch stores the current calibration parameter being set and increments the routine to the next step (except where otherwise noted).

d. Connect the DMM, set to measure approximately 500 mV, to the CALIBRATOR output.

e. Press up and release the TRIGGER COUPLING switch.

NOTE

The CALIBRATOR output will go to its LO level on odd CAL steps and to its HI level on even steps.

f. CHECK—CALIBRATOR output voltage is 0 mV ± 1 mV.

g. CHECK—Readout indicates ADJUST Δ, (step) 1, 100 μs (for A Sweep), and 1 μs (for B Sweep).

NOTE

The readout prompts the operator by showing the control to be moved (upper left corner), the autocal step number (upper right corner), the A Sweep speed (bottom right center), and the B Sweep speed (bottom right corner) as set up by the routine. An example (from step g above) is:

ADJ Δ	1		
		100 μs	1 μs

h. Connect the Time-Mark Generator, set for 0.1 ms time markers, to the CH 1 OR X input connector via a 50 Ω BNC cable.

i. Set:

VOLTS DIV	As needed for a convenient signal display amplitude
TRACE SEP	As needed to separate the A and B Sweeps
CH 1 POSITION	As needed to view both A and B Sweeps
Horizontal POSITION	Position start of trace at the left graticule line

NOTE

Some sequential pairs of steps are iterative, i.e., the earlier step is recalled if an adjustment is made in the later step. Occasionally, on the earlier of some of these pairs, the readout may indicate "LIMIT" before the correct control setting is reached. If this occurs, proceed to the next AUTOCAL step. After the adjustment at the next step is performed, the previous step will automatically be recalled, and the adjustment may be performed in the normal manner.

j. ADJUST—ΔREF OR DLY POS and Δ controls to align both the intensified zones with the 6th time marker (near graticule center) and to superimpose the delayed B Sweep time markers. Press up and release the TRIGGER COUPLING switch.

k. CHECK—CALIBRATOR output voltage is between 398 mV and 402 mV of the reading noted in part f. Disconnect the DMM when through.

l. CHECK—Readout indicates ADJ Δ, (step) 2, 100 μs (for A Sweep), and 1 μs (for B Sweep).

m. ADJUST—ΔREF OR DLY POS control to intensify the 2nd time marker, and ADJUST—Δ control to intensify the the 10th time marker. Superimpose the delayed B Sweep time markers within 0.2 division.

n. Push up and release the TRIGGER COUPLING switch.

o. CHECK—Readout indicates ADJ Δ, (step) 3, 300 μs (for A Sweep), and 1 μs (for B Sweep).

p. ADJUST—ΔREF OR DLY POS control to intensify the 4th time marker, and ADJUST—Δ control to intensify the 28th time marker. Superimpose the delayed B Sweep time markers within 1.2 division.

Adjustment Procedure—2445 Service

q. Press up and release TRIGGER COUPLING switch. If the adjustment in step 3 was changed, step 2 will be recalled; otherwise step 4 will be initiated.

r. CHECK—Readout indicates ADJ Δ , (step) 4, 100 μs (for A Sweep), and 1 μs (for B Sweep). Set the Time-Mark Generator for 5 μs time markers.

s. ADJUST— Δ control CCW until no further movement of the B Sweep display occurs. Note the position of the 1st time marker, then adjust the Δ control CW until the 2nd time marker moves to the left and aligns with the position just noted.

t. Press up and release the TRIGGER COUPLING switch. Set the Time-Mark Generator for 10 μs time markers.

u. CHECK—Readout indicates X1, X10, HRZ CTR, (step) 5, and 10 μs (for A Sweep) and two vertical cursors appear on the display.

v. ADJUST—X1 Gain (R860) and Hrz Ctr (R801) to align the two cursors with the 2nd and 10th vertical graticule lines, then adjust X10 Gain (R850) for 1 time marker per division.

w. Press up and release TRIGGER COUPLING switch. Set the Time-Mark Generator for 10 ms time markers.

x. CHECK—Readout indicates ADJ Δ , (step) 6, 10 ms (for A Sweep), and 100 μs (for B Sweep).

y. ADJUST— Δ REF OR DLY POS control to intensify the 2nd time marker, and ADJUST— Δ control to intensify the 10th time marker. Superimpose the delayed B Sweep time markers within 0.2 division.

z. Press up and release TRIGGER COUPLING switch. Set the Time-Mark Generator for 1 μs time markers.

aa. For each step in Table 5-2, do the following:

1. Adjust the Δ REF OR DLY POS and Δ controls, as necessary, to intensify the indicated time marks on the A Sweep and superimpose the displayed B Sweep markers within the listed limits.
2. Press up and release the TRIGGER COUPLING switch.

NOTE

If the Δ control is adjusted at step 9, 12 or 14, the previous step will be repeated.

Table 5-2
Horizontal Timing

Step No.	Time-Marker Period	Δ REF Marker	Δ Marker	Superposition Tolerance In Tolerance In Divisions
7	1 μs	2	10	0.2
8	2 μs	2	10	0.2
9	2 μs	4	28	1.2
10	10 μs	2	10	0.2
11	50 μs	2	10	0.2
12	50 μs	4	28	1.2
13	0.5 μs	2	10	0.2
14	0.5 μs	4	28	1.2
15	100 ns	2	10	0.2
16	20 ns	2	10	0.1

bb. Set the TRACE SEP fully CW.

cc. For each step in Table 5-3 (except step 28), adjust the Δ control for the listed number of markers over the center 8 divisions, then press up and release the TRIGGER COUPLING switch. If the Δ control is adjusted at step 18, 20, 23, or 25, the previous step will be repeated. The 2445 intentionally skips step 28.

NOTE

Change the CH 1 VOLTS/DIV switch setting as necessary to maintain adequate signal display amplitude.

Adjustment Procedure—2445 Service

Table 5-3
Horizontal Timing

Step No.	Time-Marker Period	Markers Over 8 Divisions
17	1 μ s	8
18	1 μ s	24
19	2 μ s	8
20	2 μ s	24
21	10 μ s	8
22	50 μ s	8
23	50 μ s	24
24	500 ns	8
25	500 ns	24
26	100 ns	8
27	20 ns	8
28 ^a	skipped	
29	1 ms	8

^aFirmware in the 2445 is shared with a similar instrument, the 2465, which requires step 28. The 2445 skips step 28.

NOTE

If the remainder of the Adjustment Procedure will not be performed (in totality), readjustment of Horizontal Readout Jitter (R805) may be necessary if the X1 Gain (R860) or the X10 Gain (R850) was changed. See subsection 2 on page 5-17 for that procedure.

dd. Disconnect the test setup.

CAL 02—VERTICAL

2. Check/Adjust Vertical Preamp Gain, Gain (R638), and Vertical Centering (R639).

NOTE

If the previous step (CAL 01) was not performed, the adjustments in this subsection should only be performed if those constants that would have been set in CAL 01 are known to be correct.

a. Set the front-panel INTENSITY control at midrange.

b. Scroll to CAL 02.

c. Press up and release the TRIGGER COUPLING switch. The instrument will automatically increment through steps 100 to 111.

d. CHECK—Readout indicates CH 1 VAR, CH2 POS, (step) 111, 500 mV, and BWL.

NOTE

The readout prompts the operator by showing the controls to be moved (upper left corner and upper center), the autocal step number (upper right corner), the amplitude of signal to be applied to either the CH 1 or CH 2 connectors (lower left corner), and any other scope function that is enabled. An example (from step d above) is:

```
CH1 VAR CH2 POS      111
500 mV                BWL
```

e. Connect a 0.5 V, standard-amplitude signal from the Calibration Generator to the CH 1 OR X input connector via a 50 Ω BNC cable.

f. Use the CH 2 POSITION control to vertically position the trace to within 1 division of the center graticule line.

g. ADJUST—CH 1 POSITION and VOLTS/DIV VAR controls to obtain a 10-division horizontal signal. Press up and release the TRIGGER COUPLING switch.

h. CHECK—Readout indicates MOVE SW, CENTER CH 1 POS, (step) 112, 500 mV, and BWL; then press up and release the TRIGGER COUPLING switch.

i. ADJUST—CH 1 POSITION control carefully until the CH 1 input coupling "1 M Ω DC" indicator remains illuminated, then press up and release the TRIGGER COUPLING switch.

NOTE

In the following steps, if the "LIMIT" message appears, it probably indicates that the TRIGGER COUPLING (step) switch was moved before the required signal was applied. Press down and release the TRIGGER COUPLING switch, verify that the correct signal is applied, then press up and release the TRIGGER COUPLING switch.

j. CHECK—First step number listed in Table 5-4 appears in the readout.

k. Apply the corresponding standard-amplitude signal from the Calibration Generator, then press up and release the TRIGGER COUPLING switch.

l. Repeat steps j and k for each step-signal combination listed in Table 5-4.

Table 5-4
Vertical Calibration Signals

Autocal Step Readout Display	Standard-Amplitude Signal to Apply
113, 114 ^a	0.5 V
115	0.2 V
116	0.1 V
117	50 mV
118	20 mV
119	1 V
120	10 V

^a When step 113 is performed, step 114 is also automatically done. No indication of step 114 will be shown unless a LIMIT error is encountered.

m. Move the signal to the CH 2 input connector.

n. CHECK—Readout indicates MOVE SW, CENTER CH 2 POS, (step) 121, 500 mV, 500 mV, and BWL.

o. Set the Calibration Generator for a 500 mV standard-amplitude signal, then press up and release the TRIGGER COUPLING switch.

p. ADJUST—CH 2 VERTICAL POSITION control until the CH 1 Input Coupling “1 MΩ DC” indicator remains illuminated, then press up and release the TRIGGER COUPLING switch.

q. CHECK—Readout indicates MOVE SW, CENTER CH 2 POS, (step) 122, 500 mV, 500 mV, and BWL.

r. With the Calibration Generator set for a 500 mV standard-amplitude signal, press up and release the TRIGGER COUPLING switch.

s. ADJUST—CH 2 VERTICAL POSITION control until the CH 1 Input Coupling “1 MΩ DC” indicator remains illuminated, then press up and release the TRIGGER COUPLING switch.

t. CHECK—First step number listed in Table 5-5 appears in the readout.

u. Apply the corresponding standard-amplitude signal, then press up and release the TRIGGER COUPLING switch.

v. Repeat steps t and u for each step-signal combination listed in Table 5-5.

Table 5-5
Vertical Calibration Signals

Autocal Step Readout Display	Standard-Amplitude Signal to Apply
123, 124 ^a	0.5 V
125	0.2 V
126	0.1 V
127	50 mV
128	20 mV
129	1 V
130	10 V

^aWhen step 123 is performed, step 124 is also automatically done. No indication of step 124 will be shown unless a LIMIT error is encountered.

w. CHECK—Readout indicates MOVE SW, CENTER CH 2 POS, (step) 131, 10 V, ↓10 V, and BWL; then press up and release the TRIGGER COUPLING switch.

x. ADJUST—CH 2 POSITION control until the CH 1 Input Coupling “1 MΩ DC” indicator remains illuminated, then press up and release the TRIGGER COUPLING switch. The instrument will automatically increment through steps 132 to 142.

y. CHECK—Readout indicates MOVE SW, CENTER CH 1 POS, (step) 142, 50 mV, and BWL.

Adjustment Procedure—2445 Service

z. Move the signal to the CH 1 OR X input connector and set the Calibration Generator for a 50 mv standard-amplitude signal, then press up and release the TRIGGER COUPLING switch.

aa. ADJUST—CH 1 POSITION control until the CH 1 “1 M Ω DC” indicator remains illuminated, then press up and release the TRIGGER COUPLING switch. Wait approximately 10 seconds for automatic calibration of the ΔV cursors.

bb. CHECK—Readout indicates VERTICAL CENTER and GAIN.

cc. ADJUST—Gain (R638) for precisely 5 divisions between the two horizontal cursors.

dd. ADJUST—Vertical Centering (R639) to center the cursors on the graticule (align the cursors with the dotted 0% and 100(%) graticule lines).

ee. Press up and release the TRIGGER COUPLING switch.

CAL 03—TRIGGERING

3. Check/Adjust Triggering.

NOTE

If the previous steps (CAL 01 and CAL 02) were not performed, the adjustments in this subsection should only be performed if those constants that would have been set in CAL 01 and CAL 02 are known to be correct and if a DC Balance has been performed after a 20-minute warmup period.

a. Scroll to CAL 03.

b. Press up and release the TRIGGER COUPLING switch.

c. CHECK—Procedure automatically steps from 201 through 214 and stops at 215.

d. CHECK—Readout indicates CH 1, 500 mV, and (step) 215.

NOTE

The readout prompts the operator by showing which connector the input signal should be applied to (upper left corner), the amplitude of that signal (upper center), and the autocal step number (upper right corner). An example (from step d above) is:

CH1 500 mV 215

e. Connect a 0.5 V standard-amplitude signal from the Calibration Generator to the CH 1 OR X input connector via a 50 Ω BNC cable.

f. Press up and release the TRIGGER COUPLING switch.

g. CHECK—Readout indicates CH 1, 500 mV, and (step) 216.

h. Press up and release the TRIGGER COUPLING switch.

i. CHECK—Readout indicates CH 2, 500 mV, and (step) 217.

j. Move the signal to the CH 2 input connector. Press up and release the TRIGGER COUPLING switch.

k. CHECK—Readout indicates CH 3, 500 mV, and (step) 218.

l. Move the signal to the CH 3 input connector. Press up and release the TRIGGER COUPLING switch.

m. CHECK—Readout indicates CH 3, 2V, and (step) 219.

n. Change the generator output level to 2 V, then press up and release the TRIGGER COUPLING switch.

o. CHECK—Readout indicates CH 4, 500 mV, and (step) 220.

p. Move the signal to the CH 4 input connector and change the generator output level to 0.5 V. Press up and release the TRIGGER COUPLING switch.

q. CHECK—Readout indicates CH 4, 2V, and (step) 221.

r. Change the generator output level to 2 V, then press up and release the TRIGGER COUPLING switch.

s. Disconnect the test setup.

g. Set the generator amplitude for a 3- to 5-division display amplitude. Use the CH 1 and CH 2 POSITION controls to vertically overlay the traces near the center of the graticule area.

h. Set the Horizontal POSITION control to set the rising edge of the signal near the center vertical graticule line.

i. Press the X10 MAG button in to obtain a magnified display.

j. Pull out the B SEC/DIV knob.

k. CHECK—Readout indicates "CH 2 DLY - TURN Δ " and that the Δ control will move the leading edge of the CH 2 trace at least 1 division to either side of the CH 1 trace.

l. ADJUST— Δ control to superimpose the leading edges.

m. Push in the B SEC/DIV knob.

CAL 04—CH 2 DELAY ENABLE/DISABLE

4. Check/Adjust CH 2 Delay Enable/Disable.

a. Scroll to CAL 04.

b. Press up and release the TRIGGER COUPLING switch to initiate the routine.

c. CHECK—Readout alternately indicates "ENABLED" and "DISABLED" each time the TRIGGER COUPLING switch is pressed up and released.

d. Leave the readout display indicating "ENABLED". Press and release the A/B TRIG button to exit the routine.

e. Connect a 100 kHz, positive-going signal from the Calibration Generator fast-rise output to the CH 1 OR X and CH 2 input connectors via a 50 Ω BNC cable, a 5X attenuator, and a Dual-Input Coupler.

f. Set:

VERTICAL MODE	
CH 1 and CH 2	On (buttons in)
VOLTS/DIV	
CH 1 and CH 2	10 mV
Input Coupling	
CH 1 and CH 2	50 Ω DC
A and B SEC/DIV	10 ns (knobs locked)
TRIGGER	
SOURCE	CH 1
MODE	AUTO LVL
COUPLING	DC
SLOPE	+ (plus)

NOTE

If the CH 2 Delay Adjust feature is to be disabled for normal instrument use, perform the following steps; otherwise, proceed to step r below.

n. Reenter the Diagnostic Monitor by pressing the ΔV and Δt buttons simultaneously (hold them in), then press and hold the TRIGGER SLOPE button. Release the buttons after about 1 second.

o. Scroll to CAL 04.

p. Press up and release the TRIGGER COUPLING switch until the readout indicates "DISABLED."

q. Press and release the A/B TRIG button to return to normal operating mode.

r. Return the CAL/NO CAL jumper to the NO CAL position and disconnect the test setup.

DYNAMIC CENTERING, CRT TERMINATION, VERTICAL GAIN, VERTICAL CENTERING, TRANSIENT RESPONSE, HF ADJ, READOUT JITTER, DC BALANCE, AND X-Y PHASE DIFFERENTIAL ADJUSTMENTS

Equipment Required (see Table 4-1)

Primary Leveled-Sinewave Generator (Item 2)	5X Attenuator (Item 16)
Calibration Generator (Item 3)	Alignment Tool (Item 19)
50 Ω BNC Cable (Item 9)	Tunnel Diode Pulser (Item 22)

See **ADJUSTMENT LOCATIONS 1** and **ADJUSTMENT LOCATIONS 4**

at the rear of this manual for location of test points and adjustments.

Initial Control Settings.

Control settings not listed do not affect the procedure.

VERTICAL VOLTS/DIV

CH 1 and CH 2	10 mV
CH 1 VAR	CCW (out of detent)
CH 2 VAR	In detent

Input Coupling

CH 1 and CH 2	50 Ω DC
---------------	----------------

VERTICAL MODE

CH 1	On (button in)
CH 2, CH 3 and CH 4	Off (buttons out)
ADD, INVERT, and	
BW LIMIT	Off (buttons out)
ALT/CHOP	ALT (button out)

VERTICAL POSITION

Midrange

A and B SEC/DIV

20 ns (knobs locked)

A and B SEC/DIV VAR

In detent

Horizontal POSITION

Midrange

TRIGGER

MODE	AUTO LVL
SOURCE	VERT
COUPLING	DC
SLOPE	+ (plus)
LEVEL	Midrange
HOLDOFF	In detent

ΔV

On (RATIO readout)

TRACKING/INDEP

INDEP (button out)

Δ REF OR DLY POS
and Δ

Cursors near the 3rd line
above and 3rd line below
graticule center
(6 division spacing)

INTENSITY

Left of center

READOUT INTENSITY

Right of center

SCALE ILLUM

Fully CCW

FOCUS

Best focused display

1. Adjust Dynamic Centering (R3401 and R3407).

a. Rotate the READOUT INTENSITY control from midrange to fully CW and note any horizontal and vertical shift that occurs in the readout characters.

b. ADJUST—Horizontal Dynamic Centering (R3401) to minimize the horizontal component of the shift.

c. ADJUST—Vertical Dynamic Centering (R3407) to minimize the vertical component of the shift.

d. Repeat steps a through c as necessary to minimize readout shift until no further improvement is noted.

2. Check/Adjust CRT Termination (R1501), Vertical Gain (R638), Vertical Centering (R639), High-Frequency Trans Resp (C404, R403), Vertical Readout Jitter (R618), Horizontal Readout Jitter (R805), and X-Y Phasing (C118).

NOTE

If the previous step was not performed, first setup the Initial Control Settings before the Dynamic Centering adjustments, then proceed as follows.

CRT Termination, High Frequency Transient Response, Vertical Gain, Vertical Centering, and Readout Jitter adjustments are interactive. This procedure optimizes these adjustments together.

a. Rotate the Δ REF OR DLY POS control CCW until the RATIO readout is constant.

b. Rotate the Δ control until the readout display indicates 130.0%.

c. CHECK—One cursor is near the bottom horizontal graticule line and the other is near dotted graticule line marked 100(%)

d. Rotate the Δ REF OR DLY POS control until the readout displays exactly 100.0%. The cursors should now be on or near the dotted graticule lines marked 0% and 100(%)

e. Set the CH 1 VOLTS/DIV VAR to the detent position.

NOTE

Care must be taken not to disturb the position of the controls adjusted in parts b through e during the balance of this procedure. If they are accidentally moved, repeat the procedure from the beginning.

f. Connect the high-amplitude output of the Calibration Generator to the CH 1 OR X input connector via a 50 Ω BNC cable, a Tunnel Diode Pulser, and a 5X attenuator.

g. Set the generator Period switch to 100 kHz, and set the generator amplitude control to maximum.

h. Rotate the pulser Trigger control CW (from a fully CCW position) until a stable signal first appears on the graticule. Display amplitude will be approximately 5 divisions. The oscilloscope TRIGGER LEVEL control may need to be adjusted to obtain a stable display.

NOTE

As a guide when performing the following adjustments, optimum performance is achieved when the CH 1 and CH 2 step response aberrations are $\leq 4\%$ when using 10 mV/division deflection factors (≤ 0.2 division on a 5-division signal).

i. ADJUST—CRT Termination (R1501) for best flat-top approximately 5 ns past the rising edge of the waveform. The adjustment is accessible through a hole in the top cover plate. Squeezing the output leads of the termination inductors (LR1513 and LR1514) toward each other will reduce the spike that may be present approximately 6 ns behind the leading edge.

j. ADJUST—Trans Resp adjustments (C404 and R403) alternately for the best flat top on the first 10 ns of the positive portion of the waveform.

k. ADJUST—Vertical Gain (R638) and Vertical Centering (R639) to vertically center the cursors precisely 5 divisions apart (align with the dotted 0% and 100(%) graticule lines).

l. Press the Δ V button to turn off the cursors.

m. Move the test signal to CH 2 and set the VERTICAL MODE switches to display CH 2.

n. Repeat part j for CH 2, switching between CH 1 and CH 2 as necessary, until both CH 2 and CH 1 aberrations are minimized. When minimized, leave CH 2 selected.

o. Disconnect the Calibration Generator and connect the Leveled Sine-Wave Generator to the CH 2 input via a BNC cable.

p. Set the generator for a 6-division display at the reference frequency.

q. Change the generator output frequency to 150 MHz.

r. CHECK—Display amplitude is between 4.4 divisions and 5 divisions. This bandwidth provides optimum performance of the Vertical system.

s. ADJUST—If necessary, compromise the settings in part j to obtain the best flat top with the proper bandwidth.

Adjustment Procedure—2445 Service

t. Move the input signal to CH 1 and select CH 1 for display.

u. Repeat parts p through s for CH 1. If readjustment of C404 or R403 is necessary, repeat parts j through s.

v. Set the A and B SEC/DIV switch to 1 ms.

w. Select CH 1 for display.

x. Press and release the ΔV button to obtain a ΔV display.

y. Use the Δ REF OR DLY POS control to position one cursor 3 divisions above graticule center and use the Δ control to position the other cursor 3 divisions below graticule center.

z. Connect a 1 kHz, fast-rise signal from the Calibration Generator to the CH 1 OR X input connector via a 50 Ω BNC cable.

aa. Set the generator output level for an 8-division display.

bb. Use the CH 1 Vertical and the Horizontal POSITION controls to center the CH 1 display on the graticule.

cc. ADJUST—Vertical Readout Jitter (R618) for minimum vertical jitter of the readout characters and cursors.

dd. Press the Δt button to obtain a Δt cursor display.

ee. Using the Δ REF OR DLY POS and Δ controls, position the cursors to the 2nd and 10th graticule lines.

ff. Press the X10 MAG button to magnify the display.

gg. ADJUST—Horizontal Readout Jitter (R805) for minimum horizontal jitter of the readout characters and cursors.

hh. Disconnect the test setup.

3. Set CH 1 and CH 2 DC Balance.

NOTE

The instrument must have had a 20-minute warmup prior to performing the next step to ensure accuracy.

a. Set:

Input Coupling	
CH 1 and CH 2	1 M Ω AC

b. Press up momentarily and release the CH 1 and CH 2 Input Coupling switches simultaneously.

c. CHECK—A moving dot display replaces the normal display for approximately 10 seconds, then the display returns to normal.

d. CHECK—For less than 0.2-division + 0.5 mV vertical trace shift when the CH 1 VOLTS/DIV switch is rotated through all of its settings.

e. Set the VERTICAL MODE switches to disable CH 1 and display CH 2.

f. CHECK—For less than 0.2-division + 0.5 mV vertical trace shift when the CH 2 VOLTS/DIV switch is rotated through all of its settings.

4. Adjust X-Y Phasing (C118).

a. Set:

VOLTS/DIV	
CH 1	50 mV
Input Coupling	50 Ω DC
A SEC/DIV	X-Y
VERTICAL MODE	
CH 1	On (button in)
CH 2	Off (button out)

b. Connect the Primary Leveled Sine-Wave Generator to the CH 1 OR X input connector via a 50 Ω BNC cable.

c. Set the generator frequency to 1 MHz and adjust the amplitude for a 6-division vertical signal display.

Adjustment Procedure—2445 Service

d. Use the CH 1 POSITION control to vertically center the display on the graticule.

e. ADJUST—X-Y Phasing (C118) for no opening in the ellipse.

f. Set the generator frequency to 2 MHz and adjust the amplitude for a 6-division vertical signal display.

g. CHECK—Horizontal opening in the ellipse is 0.3 division or less, measured at the center horizontal graticule line.

h. Disconnect the test setup.

i. Turn POWER Off.

MAINTENANCE

This section of the manual contains information for conducting preventive maintenance, troubleshooting, and corrective maintenance on the 2445 Oscilloscope.

STATIC-SENSITIVE COMPONENTS

The following precautions are applicable when performing any maintenance involving internal access to the instrument.



Static discharge can damage any semiconductor component in this instrument.

This instrument contains electrical components that are susceptible to damage from static discharge. Table 6-1 lists the relative susceptibility of various classes of semiconductors. Static voltages of 1 kV to 30 kV are common in unprotected environments.

When performing maintenance, observe the following precautions to avoid component damage:

1. Minimize handling of static-sensitive components.
2. Transport and store static-sensitive components or assemblies in their original containers or on a metal rail. Label any package that contains static-sensitive components or assemblies.
3. Discharge the static voltage from your body by wearing a grounded antistatic wrist strap while handling these components. Servicing static-sensitive components or assemblies should be performed only at a static-free work station by qualified service personnel.
4. Nothing capable of generating or holding a static charge should be allowed on the work station surface.
5. Keep the component leads shorted together whenever possible.

6. Pick up components by their bodies, never by their leads.

Table 6-1
Susceptibility
to Static Discharge Damage

Semiconductor Classes	Relative Susceptibility Levels ^a
MOS or CMOS microcircuits or discretes, or linear microcircuits with MOS inputs. (Most Sensitive)	1
ECL	2
Schottky signal diodes	3
Schottky TTL	4
High-frequency bipolar transistors	5
JFETs	6
Linear microcircuits	7
Low-power Schottky TTL	8
TTL (Least Sensitive)	9

^aVoltage equivalent for levels: (Voltage discharged from a 100 pF capacitor through a resistance of 100 Ω.)

1 = 100 to 500 V 4 = 500 V 7 = 400 to 1000 V(est.)
 2 = 200 to 500 V 5 = 400 to 600 V 8 = 900 V
 3 = 250 V 6 = 600 to 800 V 9 = 1200 V

7. Do not slide the components over any surface.

8. Avoid handling components in areas that have a floor or work-surface covering capable of generating a static charge.

9. Use a soldering iron that is connected to earth ground.

10. Use only approved antistatic, vacuum-type desoldering tools for component removal.

PREVENTIVE MAINTENANCE

INTRODUCTION

Preventive maintenance consists of cleaning, visual inspection, and checking instrument performance. When accomplished regularly, it may prevent instrument malfunction and enhance instrument reliability. The severity of the environment in which the instrument is used determines the required frequency of maintenance. An appropriate time to accomplish preventive maintenance is just before instrument adjustment.

GENERAL CARE

The cabinet minimizes accumulation of dust inside the instrument and should normally be in place when operating the 2445. The front cover supplied with the instrument provides both dust and damage protection for the front panel and crt, and it should be on whenever the instrument is stored or is being transported.

INSPECTION AND CLEANING

The 2445 should be visually inspected and cleaned as often as operating conditions require. Accumulation of dirt in the instrument can cause overheating and component

breakdown. Dirt on components acts as an insulating blanket, prevent efficient heat dissipation. It also provides an electrical conduction path that could result in instrument failure, especially under high-humidity conditions.

CAUTION

Avoid the use of chemical cleaning agents which might damage the plastics used in this instrument. Use a nonresidue-type cleaner, preferably isopropyl alcohol or a solution of 1% mild detergent with 99% water. Before using any other type of cleaner, consult your Tektronix Service Center or representative.

Exterior

INSPECTION. Inspect the external portions of the instrument for damage, wear, and missing parts; use Table 6-2 as a guide. Instruments that appear to have been dropped or otherwise abused should be checked thoroughly to verify correct operation and performance. Deficiencies found that could cause personal injury or could lead to further damage to the instrument should be repaired immediately.

Table 6-2
External Inspection Check List

Item	Inspect For	Repair Action
Cabinet, Lid, Front Panel	Cracks, scratches, deformations, damaged hardware or gaskets.	Touch up paint scratches and replace defective components.
Front-panel Controls	Missing, damaged, or loose knobs, buttons, and controls.	Repair or replace missing or defective items.
Connectors	Broken shells, cracked insulation, and deformed contacts. Dirt in connectors.	Replace defective parts. Clear or wash out dirt.
Carrying Handle	Correct operation.	Replace defective parts.
Accessories	Missing items or parts of items, bent pins, broken or frayed cables, and damaged connectors.	Replace damaged or missing items, frayed cables, and defective parts.

CAUTION

To prevent getting moisture inside the instrument during external cleaning, use only enough liquid to dampen the cloth or applicator.

CLEANING. Loose dust on the outside of the instrument can be removed with a soft cloth or small soft-bristle brush. The brush is particularly useful for dislodging dirt on and around the controls and connectors. Dirt that remains can be removed with a soft cloth dampened in a mild detergent-and-water solution. Do not use abrasive cleaners.

Two plastic light filters, one blue and one clear, are provided with the oscilloscope. Clean the light filters and the crt face with a soft lint-free cloth dampened with either isopropyl alcohol or a mild detergent-and-water solution.

Interior

To gain access to internal portions of the instrument for inspection and cleaning, refer to the "Removal and Replacement Instructions" in the "Corrective Maintenance" part of this section.

INSPECTION. Inspect the internal portions of the 2445 for damage and wear, using Table 6-3 as a guide. Deficiencies found should be repaired immediately. The corrective procedure for most visible defects is obvious; however, particular care must be taken if heat-damaged components are found. Overheating usually indicates other trouble in the instrument; therefore, it is important that the cause of overheating be corrected to prevent recurrence of the damage.

If any electrical component is replaced, conduct a Performance Check for the affected circuit and for other closely related circuits (see Section 4). If repair or replacement work is done on any of the power supplies, conduct a complete Performance Check and, if so indicated, an instrument readjustment (see Sections 4 and 5).

Table 6-3
Internal Inspection Check List

Item	Inspect For	Repair Action
Circuit Boards	Loose, broken, or corroded solder connections. Burned circuit boards. Burned, broken, or cracked circuit-run plating.	Clean solder corrosion with an eraser and flush with isopropyl alcohol. Resolder defective connections. Determine cause of burned items and repair. Repair defective circuit runs.
Resistors	Burned, cracked, broken, blistered.	Replace defective resistors. Check for cause of burned component and repair as necessary.
Solder Connections	Cold solder or rosin joints.	Resolder joint and clean with isopropyl alcohol.
Capacitors	Damaged or leaking cases. Corroded solder on leads or terminals.	Replace defective capacitors. Clean solder connections and flush with isopropyl alcohol.
Semiconductors	Loosely inserted in sockets. Distorted pins.	Firmly seat loose semiconductors. Remove devices having distorted pins. Carefully straighten pins (as required to fit the socket), using long-nose pliers, and reinsert firmly. Ensure that straightening action does not crack pins, causing them to break off.
Wiring and Cables	Loose plugs or connectors. Burned, broken, or frayed wiring.	Firmly seat connectors. Repair or replace defective wires or cables.
Chassis	Dents, deformations, and damaged hardware.	Straighten, repair, or replace defective hardware.

Maintenance—2445 Service

CAUTION

To prevent damage from electrical arcing, ensure that circuit boards and components are dry before applying power to the instrument.

CLEANING. To clean the interior, blow off dust with dry, low-pressure air (approximately 9 psi). Remove any remaining dust with a soft brush or a cloth dampened with a solution of mild detergent and water. A cotton-tipped applicator is useful for cleaning in narrow spaces and on circuit boards.

If these methods do not remove all the dust or dirt, the instrument may be spray washed using a solution of 5% mild detergent and 95% water as follows:

CAUTION

Exceptions to the following procedure are the Attenuator assemblies and the Front-Panel module. Clean these assemblies only with isopropyl alcohol as described in step 4.

1. Gain access to the parts to be cleaned by removing easily accessible shields and panels.
2. Spray wash dirty parts with the detergent-and-water solution; then use clean water to thoroughly rinse them.
3. Dry all parts with low-pressure air.

NOTE

Most of the switches used in the 2445 are sealed and the contacts are inaccessible. If cleaning is deemed necessary, use only isopropyl alcohol.

4. Clean switches with isopropyl alcohol and wait 60 seconds for the majority of the alcohol to evaporate. Then complete drying with low-pressure air.

5. Dry all components and assemblies in an oven or drying compartment using low-temperature (125° F to 150° F) circulating air.

LUBRICATION

There is no periodic lubrication required for this instrument.

SEMICONDUCTOR CHECKS

Periodic checks of the transistors and other semiconductors in the oscilloscope are not recommended. The best check of semiconductor performance is actual operation in the instrument.

PERIODIC READJUSTMENT

To ensure accurate measurements, check the performance of this instrument every 2000 hours of operation, or if used infrequently, once each year. In addition, replacement of components may necessitate readjustment of the affected circuits.

Complete Performance Check and Adjustment instructions are given in Sections 4 and 5. The Performance Check Procedure can also be helpful in localizing certain troubles in the instrument.

TROUBLESHOOTING

INTRODUCTION

Preventive maintenance performed on a regular basis should reveal most potential problems before an instrument malfunctions. However, should troubleshooting be required, the following information is provided to facilitate location of a fault. In addition, the material presented in the "Theory of Operation" and "Diagrams" sections of this manual may be helpful while troubleshooting.

TROUBLESHOOTING AIDS

Diagnostic Firmware

The operating firmware in this instrument contains diagnostic routines that aid in locating malfunctions. When instrument power is applied, power-up tests are performed to verify proper operation of much of the instrument's circuitry. If a failure is detected, this information is passed on to the operator in the form of either a CRT readout or illuminated LED indicators. The failure information directs the operator to the failing block of circuitry. If the failure is such that the processor can still execute the diagnostic routines, the user can call up specific tests to further check the failing circuitry. The specific diagnostic routines are explained later in this section.

Schematic Diagrams

Complete schematic diagrams are located on tabbed foldout pages in the "Diagrams" section. Portions of circuitry mounted on each circuit board are enclosed by heavy black lines. The assembly number and name of the circuit are shown near either the top or the bottom edge of the diagram.

Functional blocks on schematic diagrams are outlined with a wide grey line. Components within the outlined area perform the function designated by the block label. The "Theory of Operation" uses these functional block names when describing circuit operation as an aid in cross-referencing between the theory and the schematic diagrams.

Component numbers and electrical values of components in this instrument are shown on the schematic diagrams. Refer to the first page of the "Diagrams" section for the reference designators and symbols used to identify components. Important voltages and waveform reference numbers (enclosed in hexagonal-shaped boxes) are also shown on each diagram. Waveform illustrations are located adjacent to their respective schematic diagram.

Circuit Board Illustrations

Circuit board illustrations showing the physical location of each component are provided for use in conjunction with each schematic diagram. Each board illustration is found in the "Diagrams" section on the back of a foldout page, preceding the first schematic diagram(s) to which it relates.

The locations of waveform test points are marked on the circuit board illustrations with hexagonal outlined numbers corresponding to the waveform numbers on both the schematic diagram and the waveform illustrations.

Circuit Board Locations

The placement in the instrument of each circuit board is shown in a board locator illustration. This illustration is located on the foldout page along with the circuit board illustration.

Power Distribution Diagrams

Power Distribution diagrams (diagrams 11 and 12) are provided in the "Diagrams" section to aid in troubleshooting power-supply problems.

Circuit Board Interconnection Diagram

A circuit board interconnection diagram (diagram 13) and tables listing the interconnecting pins and signals carried are provided in the "Diagram" section following the Power Distribution diagrams.

Grid Coordinate System

Each schematic diagram and circuit board illustration has a grid border along its left and top edges. A table located adjacent to each diagram lists the grid coordinates of each component shown on that diagram. To aid in physically locating components on the circuit board, this table also lists the grid coordinates of each component on the circuit board illustration.

Near each circuit board illustration is an alphanumeric listing of all components mounted on that board. The second column in each listing identifies the schematic diagram on which each component can be found. These component-locator tables are especially useful when more than one schematic diagram is associated with a particular circuit board.

Troubleshooting Charts

The troubleshooting charts contained in the "Diagrams" section are to be used as an aid in locating malfunctioning circuitry. To use the charts, begin with the Preliminary Tests flowchart. This chart will help identify problem areas and will direct you to other appropriate charts for further troubleshooting.

Some malfunctions, especially those involving multiple simultaneous failures, may require more elaborate troubleshooting approaches with references to circuit descriptions in the "Theory of Operation" section of this manual.

Component Color Coding

Information regarding color codes and markings of resistors and capacitors is located on the color-coding illustration (Figure 9-1) at the beginning of the "Diagrams" section.

RESISTOR COLOR CODE. Resistors used in this instrument are carbon-film, composition, or precision metal-film types. They are usually color coded with the EIA color code; however, some metal-film type resistors may have the value printed on the body. The color code is interpreted starting with the stripe nearest to one end of the resistor. Composition resistors have four stripes; these represent two significant digits, a multiplier, and a tolerance value. Metal-film resistors have five stripes representing three significant digits, a multiplier, and a tolerance value.

CAPACITOR MARKINGS. Capacitance values of common disc capacitors and small electrolytics are marked on the side of the capacitor body. White ceramic capacitors are color coded in picofarads, using a modified EIA code.

Dipped tantalum capacitors are color coded in microfarads. The color dot indicates both the positive lead and the voltage rating. Since these capacitors are easily destroyed by reversed or excessive voltage, be careful to observe the polarity and voltage rating when replacing them.

DIODE COLOR CODE. The cathode end of each glass-encased diode is indicated by either a stripe, a series of stripes or a dot. For most diodes marked with a series of stripes, the color combination of the stripes identifies three digits of the Tektronix Part Number, using the resistor color-code system. The cathode and anode ends of a metal-encased diode may be identified by the diode symbol marked on its body.

Semiconductor Lead Configurations

Figure 9-2 in the "Diagrams" section shows the lead configurations for semiconductor devices used in the instrument. These lead configurations and case styles are typical of those used at completion of the instrument design. Vendor changes and performance improvement changes may result in changes of case styles or lead configurations. If the device in question does not appear to match the configuration shown in Figure 9-2, examine the associated circuitry or consult a manufacturer's data sheet.

Multipin Connectors

Multipin connector orientation is indexed by two triangles; one on the holder and one on the circuit board. Slot numbers are usually molded into the holder. When a connection is made to circuit board pins, ensure that the index on the holder is aligned with the index on the circuit board (see Figure 6-1).

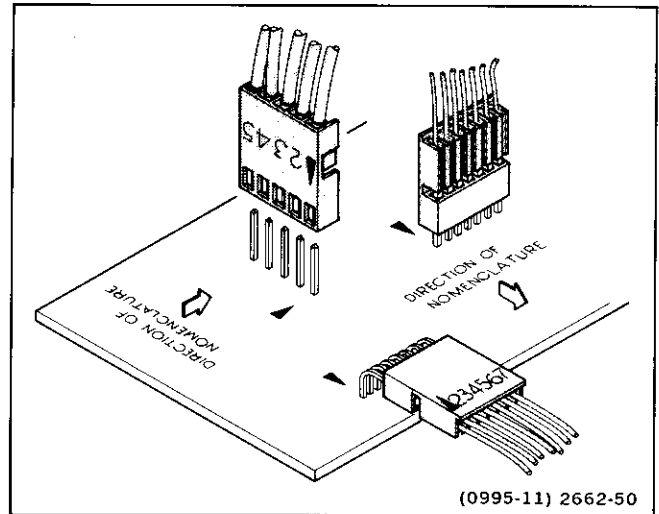

Figure 6-1. Multipin connector orientation.

TROUBLESHOOTING EQUIPMENT

The equipment listed in Table 4-1 of this manual, or equivalent equipment, may be useful when troubleshooting this instrument.

TROUBLESHOOTING TECHNIQUES

The following procedure is arranged in an order that enables checking simple trouble possibilities before requiring more extensive troubleshooting. The first two steps use di-

agnostic aids inherent in the instrument's operating firmware and will locate many circuit faults. The next four procedures are check steps that ensure proper control settings, connections, operation, and adjustment. If the trouble is not located by these checks, the remaining steps will aid in locating the defective component. When the defective component is located, replace it using the appropriate replacement procedure given under "Corrective Maintenance" in this section.

CAUTION

Before using any test equipment to make measurements on static-sensitive, current-sensitive, or voltage-sensitive components or assemblies, ensure that any voltage or current supplied by the test equipment does not exceed the limits of the component to be tested.

1. Power-up Tests

The 2445 performs automatic verification of much of the instrument's circuitry when power is first applied. The "Kernel" tests verify proper operation of the Microprocessor, the ROM, and the RAM. If all Kernel tests pass, a second level of checks, the "Confidence" tests, are performed. The Confidence tests, when passed, give the user a high degree of assurance that the instrument is functioning properly.

If a Kernel test or Confidence test fails, the area of failure is identified either by a message on the crt (if the instrument is able to produce a display) or by an error code displayed on the front-panel LED indicators. If a failure occurs, refer to the "Diagnostic Routines" discussion later in this section for definitions of error messages and LED error codes.

Once a problem area has been identified, the associated troubleshooting procedure should be performed to further isolate the problem. The troubleshooting procedures are located on tabbed-foldout pages in the "Diagrams" section at the rear of this manual.

2. Diagnostic Tests and Exerciser Routines

Each of the tests automatically performed at power up, along with several other circuit exercising routines, may be individually selected by the user to further clarify the nature of a suspected failure. The desired test or exerciser is selected by "scrolling" through a menu of the available routines when under control of the "Diagnostic Monitor." Entry into the Diagnostic Monitor and its uses are explained in the "Diagnostic Routines" discussion later in this section.

3. Check Control Settings

Incorrect control settings can give a false indication of instrument malfunction. If there is any question about the correct function or operation of any control, refer to either the "Operating Information" in Section 2 of this manual or to the 2445 Operators Manual.

4. Check Associated Equipment

Before proceeding, ensure that any equipment used with the 2445 is operating correctly. Verify that input signals are properly connected and that the interconnecting cables are not defective. Check that the ac-power-source voltage to all equipment is correct.

5. Visual Check

Perform a visual inspection. This check may reveal broken connections or wires, damaged components, semiconductors not firmly mounted, damaged circuit boards, or other clues to the cause of an instrument malfunction.

6. Check Instrument Performance and Adjustment.

Check the performance of either those circuits where trouble appears to exist or the entire instrument. The apparent trouble may be the result of misadjustment. Complete performance check and adjustment instructions are given in Sections 4 and 5 of this manual.

7. Isolate Trouble to a Circuit

To isolate problems to a particular area, use any symptoms noticed to help locate the trouble. Refer to the troubleshooting charts in the "Diagrams" section as an aid in locating a faulty circuit.

When trouble symptoms appear in more than one circuit, first check the power supplies; then check the affected circuits by taking voltage and waveform readings. Check first for the correct output voltage of each individual supply. These voltages are measured between the power supply test points and ground (see schematic diagrams 8, 9, and 10, and associated circuit board illustrations in the "Diagrams" section). If the power-supply voltages and ripple are within the listed ranges, the supply can be assumed to be working correctly. If they are outside the range, the supply may be either misadjusted or operating incorrectly.

The Low Voltage Power Supply levels are interdependent. All the low voltage supplies use the +10 V reference for their reference levels. If more than one of the low voltage supplies appears defective, repair them in the following order: +10 V REF, +5 V Digital, +87 V, +42 V, +15 V, +5 V Analog, -15 V, -8 V, and -5 V.

Maintenance—2445 Service

A defective component elsewhere in the instrument can create the appearance of a power-supply problem and may also affect the operation of other circuits. Use the power supply troubleshooting charts to aid in locating the problem.

8. Check Circuit Board Interconnections

After the trouble has been isolated to a particular circuit, again check for loose or broken connections, improperly seated semiconductors, and heat-damaged components.

9. Check Voltages and Waveforms

Often the defective component can be located by checking circuit voltages or waveforms. Typical voltages are listed on the schematic diagrams. Waveforms indicated on the schematic diagrams by hexagonal-outlined numbers are shown adjacent to the diagrams. Waveform test points are shown on the circuit board illustrations.

NOTE

Voltages and waveforms indicated on the schematic diagrams are not absolute and may vary slightly between instruments. To establish operating conditions similar to those used to obtain these readings, see the voltage and waveform setup conditions preceding the waveform illustrations.

Note the recommended test equipment, front-panel control settings, voltage and waveform conditions, and cable-connection instructions. Any special control settings required to obtain a given waveform are noted under the waveform illustration. Changes to the control settings from the initial setup, other than those noted, are not required.

10. Check Individual Components

The following procedures describe methods of checking individual components. Two-lead components that are soldered in place are most accurately checked by first disconnecting one end from the circuit board. This isolates the measurement from the effects of the surrounding circuitry. See Figure 9-1 for component value identification and Figure 9-2 for semiconductor lead configurations.

WARNING

To avoid electric shock, always disconnect the instrument from the ac power source before removing or replacing components.

CAUTION

When checking semiconductors, observe the static-sensitivity precautions located at the beginning of this section.

TRANSISTORS. A good check of a transistor is actual performance under operating conditions. A transistor can most effectively be checked by substituting a known-good component. However, be sure that circuit conditions are not such that a replacement transistor might also be damaged. If substitute transistors are not available, use a dynamic-type transistor checker for testing. Static-type transistor checkers are not recommended, since they do not check operation under simulated operating conditions.

When troubleshooting transistors in the circuit with a voltmeter, measure both the emitter-to-base and emitter-to-collector voltages to determine whether they are consistent with normal circuit voltages. Voltages across a transistor may vary with the type of device and its circuit function.

Some of these voltages are predictable. The emitter-to-base voltage for a conducting silicon transistor will normally range from 0.6 V to 0.8 V. The emitter-to-collector voltage for a saturated transistor is about 0.2 V. Because these values are small, the best way to check them is by connecting a sensitive voltmeter across the junction rather than comparing two voltages taken with respect to ground. If the former method is used, both leads of the voltmeter must be isolated from ground.

If voltage values measured are less than those just given, either the device is shorted or no current is flowing in the external circuit. If values exceed the emitter-to-base values given, either the junction reverse biased or the device is defective. Voltages exceeding those given for typical emitter-to-collector values could indicate either a nonsaturated device operating normally or a defective (open-circuited) transistor. If the device is conducting, voltage will be developed across the resistors in series with it; if open, no voltage will be developed across the resistors unless current is being supplied by a parallel path.

CAUTION

When checking emitter-to-base junctions, do not use an ohmmeter range that has a high internal current. High current may damage the transistor. Reverse biasing the emitter-to-base junction with a high current may degrade the current-transfer ratio (Beta) of the transistor.

A transistor emitter-to-base junction also can be checked for an open or shorted condition by measuring the resistance between terminals with an ohmmeter set to a range having a low internal source current, such as the R X 1 k Ω range. The junction resistance should be very high in one direction and much lower when the meter leads are reversed.

When troubleshooting a field-effect transistor (FET), the voltage across its elements can be checked in the same manner as previously described for other transistors. However, remember that in the normal depletion mode of operation, the gate-to-source junction is reverse biased; in the enhanced mode, the junction is forward biased.

INTEGRATED CIRCUITS. An integrated circuit (IC) can be checked with a voltmeter, test oscilloscope, or by direct substitution. A good understanding of circuit operation is essential when troubleshooting a circuit having IC components. Use care when checking voltages and waveforms around the IC so that adjacent leads are not shorted together. An IC test clip provides a convenient means of clipping a test probe to an IC.

HYBRIDS. Hybrid components can best be checked by observing voltages and waveforms on the circuit board. Measurements should not be made on any hybrid component while out of the circuit as they may easily be damaged. Direct substitution is the best troubleshooting method when a hybrid failure is suspected.

CAUTION

When checking a diode, do not use an ohmmeter scale that has a high internal current. High current may damage a diode. Checks on diodes can be performed in much the same manner as those on transistor emitter-to-base junctions. Do not check tunnel diodes or back diodes with an ohmmeter; use a dynamic tester, such as the TEKTRONIX 576 Curve Tracer.

DIODES. A diode can be checked for either an open or a shorted condition by measuring the resistance between terminals with an ohmmeter set to a range having a low internal source current, such as the R X 1 k Ω range. The diode resistance should be very high in one direction and much lower when the meter leads are reversed.

Silicon diodes should have 0.6 to 0.8 V across their junctions when conducting. Higher readings indicate that they are either reverse biased or defective, depending on polarity.

RESISTORS. Check resistors with an ohmmeter. Refer to the "Replaceable Electrical Parts" list for the tolerances of resistors used in this instrument. A resistor normally does not require replacement unless its measured value varies widely from its specified value and tolerance.

INDUCTORS. Check for open inductors by checking continuity with an ohmmeter. Shorted or partially shorted inductors can usually be found by check the waveform response when high-frequency signals are passed through the circuit.

CAPACITORS. A leaky or shorted capacitor can best be detected by checking resistance with an ohmmeter set to one of the highest ranges. Do not exceed the voltage rating of the capacitor. The resistance reading should be high after the capacitor is charged to the output voltage of the ohmmeter. An open capacitor can be detected with a capacitance meter or by checking whether the capacitor passes ac signals.

ATTENUATORS. The Attenuators are built as complete assemblies and should not be taken apart. If an Attenuator is suspected as having failed, direct substitution is the recommended troubleshooting method.

11. Repair and Adjust the Circuit.

If any defective parts are located, follow the replacement procedures given under "Corrective Maintenance" in this section. After any electrical component has been replaced, the performance of that circuit and any other closely related circuit should be checked. Since the power supplies affect all circuits, performance of the entire instrument should be checked if work has been done on the power supplies or if the power transformer has been replaced. Readjustment of the affected circuitry may be necessary. Refer to the "Performance Check" and "Adjustment Procedure", Sections 4 and 5 of this manual.

DIAGNOSTIC ROUTINES

The diagnostic routines contained in the 2445 operating firmware consist of the various power-up tests that are automatically performed when power is first applied and several circuit exerciser routines. The test or exerciser routines are selected by "scrolling" through a menu of available routines when the firmware is under control of the Diagnostic Monitor. Monitor control is indicated by the message "DIAGNOSTIC. PUSH A/B TRIG TO EXIT" displayed in the top crt graticule division.

Entry into the monitor is automatic if a power-up test fails. The user may also force entry into the Diagnostic Mon-

Maintenance—2445 Service

itor from the normal operating mode by holding in the front-panel ΔV and Δt push buttons and then pressing the front-panel SLOPE push button. Exiting the monitor is accomplished by pressing in the A/B TRIG push button, as instructed by the crt readout display.

Depending on how the Diagnostic Monitor was entered (from normal mode or as a result of a power-up test failure), the first menu item displayed may vary; entry into the moni-

tor from the normal mode begins at ALL TESTS while entry from power up starts at the first failed test. Since, in a failure mode, the crt readout may not be able to display the selected menu item, the VERT TRIGGER SOURCE indicator illuminates as a reference when ALL TESTS is selected. With the VERT TRIGGER SOURCE indicator illuminated, the user may scroll to the desired test or exerciser routine using the test order called out in Table 6-4. Whether the menu is displayed or not, scrolling is accomplished by pressing the front-panel TRIGGER MODE switch either up to increment or down to decrement the menu position by one.

Table 6-4
Sequence of Diagnostic Tests and Exerciser Routines

Routine Type	Type Number	Routine Name	Error Code	Error Code Meaning
All Tests ^a	00	All	ZZ	The left digit is the option number and the right digit is the test number of the first failing test of the last ALL TESTS run. When looping, it shows the last failing test.
Test	01	Interrupt Request	01	Interrupt request is missing or has wrong period.
Test	02	Switch Stuck	01 02 08 10 28 30 44 48 50 61 62 64 68 70 ^b	Trigger COUPLING down. Trigger COUPLING up. CH 1 Coupling down. CH 1 Coupling up. CH 2 Coupling down. CH 2 Coupling up. Δt (delta time). ΔV (delta volts). Trigger SLOPE Trigger SOURCE down. Trigger SOURCE up. Trigger MODE down. Trigger MODE up. A/B TRIG select.
Test	03	Readout Board	01 02	Shift register failure. Readout RAM failure.
Test	04	EAROM	X1 X8 1X	Parity error on read (bit 0 set). Bad read after write (bit 3 set). Bad checksum (bit 4 set).
Test	05	Main Board	01 X2 X4 2X 4X	AUTO LVL failed to trigger. Negative level not negative enough. Negative level too negative. Positive level not positive enough. Positive level too positive.
Exerciser	01	Pots and Switches	None	
Exerciser	02	EAROM Examine	None	
Exerciser	03	Cycle Error Clear	None	
Exerciser	04	Display ROM Headers	None	

^aVERT TRIG SOURCE indicator lights when in ALL TESTS as a visual reference in the event a crt display can not be produced.

^bIf the A/B TRIG switch is stuck on power up, the oscilloscope will branch to "normal" operation after a short delay. The associated error message will only be visible momentarily if the crt is warmed-up.

Maintenance—2445 Service

Routine Control

When the desired Test or Exerciser has been selected, the operator has two types of control that may be exercised over the routine: START/STOP and LOOP.

Starting or stopping the execution of the selected routine is controlled by the front-panel TRIGGER COUPLING switch. Pressing the switch up starts the routine; pressing it down stops it.

All of the test routines, except EAROM—TEST 04, may be set to LOOP mode (continuously repeated) by pressing the front-panel TRIGGER SOURCE switch up while the routine is selected but not executing. The LOOP feature will cause the routine to be continuously repeated once started until stopped when the operator presses the COUPLING switch down. Once the routine is stopped, the LOOP feature may be disabled by pressing the SOURCE switch down.

While a Test or Exerciser routine is executing, the Diagnostic Monitor Control message on the top line of the crt display will be cleared as an indication that a routine is running. When test routines are looping, the message "LOOP" is displayed in the bottom division of the crt graticule.

Display Format

The Tests and Exercisers routines display information about the routine type and number, as well as any test results, at the bottom of the crt display. The readout line is formatted as follows:

OD TYPE XY STATUS ZZ LOOP OD<ABCC>

The information is defined as follows:

"OD" is a two-character option designator identifying the option that this particular line of diagnostic information refers to (see Options manual for details). For the basic instrument, the OD location is blank.

"TYPE" refers to routine type: All Tests (ALL), Test (TEST), Exerciser (EXER), or Calibration (CAL).

"X" indicates which bit of the "Option Select Register" is set to turn on the option called out by "OD" (see Options manual for description of Options Select Register). This bit is zero for the basic instrument.

"Y" is the TYPE number of the routine (see the "Type Number" column of Table 6-4).

"STATUS" shows the results of the last time a selected test routine ran: either PASS or FAIL. This space is blank for exerciser and calibration routines. When the diagnostics are called up from normal operating mode, the space will be blank until the selected test is executed.

"ZZ" is a two-digit error code identifying the nature of the failure in a failed test (see the "Error Code" column of Table 6-4).

"LOOP" indicates when a selected test is set to the LOOP mode.

"OD<ABCC>" is the CYCLE mode failure indicator. When the CYCLE mode is activated (see CYCLE ERROR CLEAR description), data will be written to the EAROM about the first test failure that occurs. This information will be displayed until the operator performs the CYCLE ERROR CLEAR routine (Exerciser 03). The information displayed is an abbreviated version of the previous items:

"OD" is a two-character option designator showing which option failed first while in the CYCLE mode (the same codes as for "OD" at the start of the readout line).

"A" identifies the option-select bit for the failing option (the same code as for "X").

"B" is the test Type Number where the failure occurred (the same codes as for "Y").

"CC" is the error code for the test (the same codes as for "ZZ").

Kernel Tests

The Kernel tests are those tests which, when failed, are considered "fatal" to the operation of the Microprocessor. Failure of a Kernel test will cause the front-panel TRIG'D indicator to flash, and certain of the other front-panel indicators will be illuminated with an error code. The code points to the area of failure as indicated in Table 6-5. Tables 6-6 and 6-7 are used to determine the option and device numbers used in Table 6-5. Only the basic instrument codes are given in Table 6-5. Option codes are defined in the "Options Service Manual."

Table 6-5
Kernel Test Failure Codes

Failure Codes		
Option	Device	Failing Device
0	0	Control Board RAM
0	1	ROM at 9000 (hex)
0	2	ROM at A000 (hex)
0	3	ROM at C000 (hex)
0	4	ROM at E000 (hex)

Table 6-6
Front-Panel LED Option Codes

Option Code				Option Number (in hex)	Option Name
CH 1 LED (bit 3)	CH 2 LED (bit 2)	CH 3 LED (bit 1)	CH 4 LED (bit 0)		
OFF	OFF	OFF	OFF	0	Basic Instrument
ON	ON	ON	ON	F	Options Buffer Board

Table 6-7
Front-Panel LED Device Codes

READY LED (bit 2)	Device Code		Device Number
	+ LED (bit 1)	- LED (bit 0)	
OFF	OFF	OFF	0
OFF	OFF	ON	1
OFF	ON	OFF	2
OFF	ON	ON	3
ON	OFF	OFF	4
ON	OFF	ON	5
ON	ON	OFF	6
ON	ON	ON	7

Even if a Kernel test fails, the operator may try to go to normal oscilloscope operation by pressing the A/B TRIG select push button. Depending on the exact nature of the failure, the instrument may or may not be functional.

Kernel tests are automatically executed at power up. The Kernel tests are divided into RAM tests and ROM tests as follows:

RAM TEST. This test is a complete march test. The RAM is first filled with zeros. The first location is then read, checking that only zeros are present. (In later cycles this ensures that a previous write hasn't written to the location.) A "1" is walked through each bit of the addressed location and read back after each write to ensure only one bit at a time changes. Each of the succeeding address locations is read, then written to in the same way until the RAM is filled with ones. After the RAM is filled, a "0" is walked through each bit location in a similar manner.

Test checks: RAM address decoding, RAM address lines, RAM data lines, and Data Bus Buffers.

ROM TEST. The ROM test performs three checks on each of the system read-only memories.

Data Bus Drive—Two locations containing complementary data patterns are read.

Test checks: Data bus lines and the Data Bus Driver.

Correct Part—A byte in the ROM being checked is compared to the most-significant byte of the addressed ROM block (starting address of where the ROM should be installed).

Test checks: ROM address decoding and proper installation of ROM components.

Checksum—A sixteen bit, spiral-add checksum is calculated and compared to a two-byte value stored in ROM being checked.

Test checks: ROM contents, ROM addressing, ROM data lines, and the Data Bus Driver.

Confidence Tests

The Confidence tests provide checks for much of the remaining circuitry to ensure that instrument operation is correct. Confidence tests are performed automatically at power up after the Kernel is determined to be functional or initiated by the operator from the Diagnostic Monitor.

A failure of any Confidence test during power up will pass control to the Diagnostic Monitor; this permits the test results to be examined. Descriptions of the Confidence tests follow.

Maintenance—2445 Service

INTERRUPT REQUEST (Test 01). Ten consecutive interrupt cycles are checked to ensure that succeeding interrupts occur not more than 4.5 ms apart (5600 “E” cycles).

Test checks: Interrupt Timer circuitry.

SWITCH STUCK (Test 02). The front-panel, momentary-contact switches are scanned, checking for a closed switch. At power up, the test runs immediately.

By holding one of the momentary switches in a closed position when power is first applied, this test will fail, and the Diagnostic Monitor will be entered. When the test is started from the Diagnostic Monitor, a one-half second delay is incorporated to allow the COUPLING (test start) switch to return to its normal (open) position. Table 6-4 defines the error codes that may be encountered when a switch is detected as closed.

NOTE

When the user presses the COUPLING switch to stop this test, an error code may be generated. This is normal and does not indicate an actual failure.

Test checks: Momentary switches, row scanning circuitry, and column scanning circuitry.

READOUT BOARD (Test 03). This two-part test checks the interface to the Readout Board from the Microprocessor and the character RAM circuits.

Processor Interface Test—The Microprocessor loads the three, eight-bit shift registers with an alternating bit pattern that is then shifted back to the processor for comparison.

Test checks: Data Registers, data strobes (clocks), and the data input and output lines.

RAM Test—A “1” is rotated through each byte of the Readout RAM, one bit at a time. Each time an additional bit is rotated into the byte, the byte is loaded into the processor interface and clocked back to the processor for comparison. The byte is then restored to its original content, and each successive byte is tested in the same manner.

Test checks: Readout RAM addressing, Readout RAM data lines, and RAM read/write capability.

EAROM (Test 04). Three checks are performed on the EAROM to verify its contents and the interface circuitry.

Read/Write Test—The contents of one location are read, modified, and then reread to verify functioning of the device interface.

Test checks: EAROM input and output lines, EAROM mode control, EAROM reading and writing, and the EAROM clock.

Checksum Test—The contents of locations containing calibration constants are checksummed using a serial-add technique. The result is compared to the contents of location 0 (the checksum generated at the time of calibration).

Test checks: EAROM addressing and EAROM contents.

Parity Test—As each of the calibration constants is read for the Checksum test above, the parity of each 14-bit word is checked.

Test checks: EAROM data retention and EAROM reading.

MAIN BOARD (Test 05). The AUTO LVL triggering feature (a routine stored in firmware) is operated to detect the peaks of a Line Trigger signal. Detected peaks are compared to expected values to verify operation (and calibration) of interrelated signal processing circuits.

Test checks: Line Trigger source, the A Trigger generation circuitry, and Control DAC U2234 (located on the Control board).

Exerciser Routines

The Exerciser routines allow the operator to set and examine various bytes of control data used in determining instrument function.

POTS AND SWITCHES (Exerciser 01). This routine displays the values that the Microprocessor detects as the various digitized pots and switches are activated. The top line of the crt display has the following format:

AA BB CC DEEE FF GG HI JJ KL

The format is defined as follows:

“AA” is the code of the most-recently-activated potentiometer (see Table 6-8 for definition of pot codes).

“BB” is the current value (in hexadecimal) of pot AA.

“CC” is the previous value (in hexadecimal) of pot AA.

“D” is the DAC Multiplexer code used to select pot AA (see Table 6-9).

“EEE” is the DAC value (in hexadecimal) associated with pot AA.

“FF” is the code of the previously-activated potentiometer (see Table 6-8).

“GG” is the row code of the most-recently-activated switch (see Table 6-10 for definition of row codes).

“H” is the switch-position code: 0 for open; C for closed.

“J” is the column code of the most-recently-activated switch (see Table 6-10).

“JJ” is the row for for the previously-activated switch.

“K” is the switch-position code: 0 for open; C for closed.

“L” is the column code for the previously-activated switch.

NOTE

For all momentary switches (except A/B TRIG) only the closed position will be shown in the switch-position code locations (H and K). The A/B TRIG switch has both the open and the closed positions shown.

**Table 6-8
Potentiometer Code Numbers**

Code Number	Potentiometer
01	HOLDOFF
02	Trigger LEVEL
03	SEC/DIV VAR
04	Horizontal POSITION
05	Δ (A section)
06	Δ (B section)
07	Δ REF OR DLY POS (A section)
08	Δ REF OR DLY POS (B section)
09	CH 1 VOLTS/DIV VAR
0A	CH 2 VOLTS/DIV VAR

**Table 6-9
DAC Multiplexer “D” Codes**

D Code	Control Indicated
0	CH 1 VOLTS/DIV VAR
1	A SEC/DIV VAR
2	CH 2 VOLTS/DIV VAR
3	A Trigger LEVEL
5	Horizontal POSITION
6	HOLDOFF

NOTE

In the case of the Δ REF OR DLY POS and Δ controls, the D code position shows the two most-significant bits of the 14-bit DAC output (in hexadecimal).

Table 6-10
Pots and Switches Column
and Row Code Definitions

Row Code	Column Code	Definition	Row Code	Column Code	Definition
0	0	Trig COUPLING Down	5	0	B SEC/DIV LSB
0	1	Trig COUPLING Up	5	1	B SEC/DIV Bit 2
0	2	Unused	5	2	B SEC/DIV Bit 3
0	3	CH 1 Coupling Down	5	3	B SEC/DIV Bit 4
0	4	CH 1 Coupling Up	5	4	B SEC/DIV MSB
1	0	CH 4 VOLTS/DIV	6	0	CH 1 VERT MODE
1	1	CH 3 VOLTS/DIV	6	1	CH 2 VERT MODE
1	2	Unused	6	2	ADD VERT MODE
1	3	CH 2 Coupling Down	6	3	CH 3 VERT MODE
1	4	CH 2 Coupling Up	6	4	CH 4 VERT MODE
2	0	CH 1 VOLTS/DIV LSB	7	0	Unused
2	1	CH 1 VOLTS/DIV Bit 2	7	1	B ENDS A
2	2	CH 1 VOLTS/DIV Bit 3	7	2	Unused
2	3	CH 1 VOLTS DIV MSB	7	3	CHOP/ALT
2	4	CH 2 INVERT	7	4	BW LIMIT
3	0	CH 2 VOLTS/DIV LSB	8	0	X10 MAG
3	1	CH 2 VOLTS/DIV Bit 2	8	1	TRACKING/INDEP
3	2	CH 2 VOLTS/DIV Bit 3	8	2	Δt
3	3	CH 2 VOLTS/DIV MSB	8	3	ΔV
3	4	Horiz Display Select	8	4	Trig SLOPE
4	0	A SEC/DIV LSB	9	0	Trig SOURCE Down
4	1	A SEC/DIV Bit 2	9	1	Trig SOURCE Up
4	2	A SEC/DIV Bit 3	9	2	Trig MODE Down
4	3	A SEC/DIV Bit 4	9	3	Trig MODE Up
4	4	A SEC/DIV MSB	9	4	A/B TRIG Select

EAROM EXAMINE (Exerciser 02). This routine allows the operator to examine the contents of any or all EAROM locations. The EAROM has 100 (decimal) locations (63 hexadecimal). Addresses above 63 (hex) are not defined. When entered, the Exerciser displays the contents of EAROM location 00 (hex) on the top line of the crt display. Calibration constants reside between addresses 01 (hex) and 4C (hex) and each should have odd parity as explained below. The remaining locations may be of either parity. The readout display line has the following format:

AA DDDD P

The format is defined as follows:

“**AA**” is the eight-bit address in hexadecimal notation.

“**DDDD**” is the 14-bit word stored at that location (13 bits of data and one parity bit).

“**P**” is a parity indicator for the data word: X indicates even parity; blank is odd parity.

Pushing the MODE switch up or down will increment or decrement the EAROM address by 16 (10 hex) respectively. Similarly, pushing the SOURCE switch up or down will increment or decrement the address by 1 respectively.

CYCLE ERROR CLEAR (Exerciser 03). This routine provides a way for the operator to clear the cycle-failure data written to the EAROM when a CYCLE mode failure occurs. Until the data is cleared, each time the instrument is powered up, the Diagnostic Monitor is entered and a diagonal line is display across the crt.

CYCLE mode, when entered by removing the CAL/NO CAL jumper (P501), causes the instrument to continuously

LOOP through the Power Up Diagnostic Tests (except for EAROM—Test 04). If a failure occurs, the cycle-failure data, identifying the first failure encountered, is written to a specific location in the EAROM. Thereafter, at each power up, the Diagnostic Monitor is automatically entered, and the failure data is displayed even when the instrument is returned to the normal operating configuration (CAL/NO CAL jumper in the NO CAL position). Interpretation of the cycle failure data is explained in the "Display Format" description provided earlier in this section. The error data must be cleared from the EAROM location to eliminate the CYCLE mode error display.

Clearing the EAROM location is done by scrolling to the EAROM CLEAR exerciser and pressing the following switches in sequence:

COUPLING up (starts exerciser),
SOURCE down,
MODE down, then
COUPLING down.

When the EAROM CLEAR routine is successfully executed, the cycle failure data and the diagonal line will disappear from the display.

DISPLAY ROM HEADERS (Exerciser 04). This routine displays the Standard Tektronix ROM Header of each system ROM on the top line of the crt display. The readout line has the following format:

CCCC PPPP SS AAAA

The definition of the format is as follows:

"CCCC" is a two-byte hexadecimal checksum.

"PPPP" is the four middle digits of the ROM part number.

"SS" is the suffix of the ROM part number (version number).

"AAAA" is the starting address of the ROM (address where the ROM should be installed).

Pressing the COUPLING switch up increments the routine to the next ROM Header; pressing it down exits the routine.

CONTROLLER LATCHES EXERCISER. This routine is not user selectable, but it runs automatically when the Diagnostic Monitor is waiting for a key activation.

The routine first sets latches U2034 and U2134 (diagram 2). It then pulses the BSWPCLK line (pin 13 of U2596, diagram 1), as a scope trigger, and rotates a "0" through 15 of the 16 latched bits. Bit 16 is not set since it would reset Interrupt Timer U2268 (diagram 1) and upset processor interrupt timing. By externally triggering a test oscilloscope on the BSWPCLK signal line and observing the shifted timing relationships of the latched signals, proper operation of the DAC latches may be verified.

NOP KERNEL EXERCISER. This exerciser is not a firmware routine, but rather a forced hardware condition. It is best suited for troubleshooting an inoperative Control Board, as it exercises only the Microprocessor address bus and the associated Address Decode circuitry. By moving Jumper P503 (diagram 1) to the Diagnostic position, Data Bus Buffers U2194 and U2294 are disabled, and the Microprocessor is forced into a NOP (no operation) loop. This causes the address on the address bus to be continuously incremented for exercising the Address Decode circuitry. Troubleshooting of kernel addressing with an oscilloscope or logic analyzer is then possible.

CORRECTIVE MAINTENANCE

INTRODUCTION

Corrective maintenance consists of component replacement and instrument repair. This part of the manual describes special techniques and procedures required to replace components in this instrument. If it is necessary to ship your instrument to a Tektronix Service Center for repair or service, refer to the "Instrument Repackaging Instructions" at the end of this section.

MAINTENANCE PRECAUTIONS

To reduce the possibility of personal injury or instrument damage, observe the following precautions.

1. Disconnect the instrument from the ac power source before removing or installing components.
2. Verify that the line-rectifier filter capacitors are discharged prior to performing any servicing.
3. Use care not to interconnect instrument grounds which may be at different potentials (cross grounding).
4. When soldering on circuit boards or small insulated wires, use only a 15-watt, pencil-type soldering iron.

OBTAINING REPLACEMENT PARTS

Most electrical and mechanical parts can be obtained through your local Tektronix Field Office or representative. However, many of the standard electronic components can usually be obtained from a local commercial source. Before purchasing or ordering a part from a source other than Tektronix, Inc., please check the "Replaceable Electrical Parts" list for the proper value, rating, tolerance, and description.

NOTE

Physical size and shape of a component may affect instrument performance, particularly at high frequen-

cies. Always use direct-replacement components, unless it is known that a substitute will not degrade instrument performance.

Special Parts

In addition to the standard electronic components, some special parts are used in the 2445. These components are manufactured or selected by Tektronix, Inc. to meet specific performance requirements, or are manufactured for Tektronix, Inc. in accordance with our specifications. The various manufactures can be identified by referring to the "Cross Index-Manufacturer's Code number to Manufacturer" at the beginning of the "Replaceable Electrical Parts" list. Many of the mechanical parts used in this instrument were manufactured by Tektronix, Inc. Order all special parts directly from your local Tektronix Field Office or representative.

Ordering Parts

When ordering replacement parts from Tektronix, Inc., be sure to include all of the following information:

1. Instrument type (include modification or option numbers).
2. Instrument serial number.
3. A description of the part (if electrical, include its full circuit component number)
4. Tektronix part number.

MAINTENANCE AIDS

The maintenance aids listed in Table 6-11 include items required for performing most of the maintenance procedures in this instrument. Equivalent products may be substituted for the examples given, provided their characteristics are similar.

Table 6-11
Maintenance Aids

Description	Specification	Usage	Example
1. Soldering Iron	15 to 25 W.	General soldering and unsoldering.	Antex Precision Model C.
2. Flat-bit Screwdriver	3-inch shaft, 3/32-inch bit.	Assembly and disassembly.	Xcelite Model R3323.
3. Torx Screwdriver	Tip sizes: #T9, #T10, #T15, #T20.	Assembly and disassembly.	Tektronix Part Numbers #T9 003-0965-00 #T10 003-0815-00 #T15 003-0966-00 #T20 003-0866-00
4. Nutdrivers	3/16 inch, 1/4 inch.	Assembly and disassembly	Xcelite #6 and #8.
5. Open-end Wrenches	1/4 inch, 5/16 inch, 7/16 inch	Assembly and disassembly.	
6. Allen Wrenches	0.050 inch, 1/16 inch	Assembly and disassembly.	
7. Long-nose Pliers		Component removal and replacement.	Diamalloy Model LN55-3.
8. Diagonal Cutters		Component removal and replacement.	Diamalloy Model M554-3.
9. Vacuum Solder Extractor	No static charge retention.	Unsoldering static sensitive devices and components on multilayer boards.	Pace Model PC-10.
10. Spray Cleaner	No-Noise	Switch and Pot cleaning.	Tektronix Part Number 006-0442-02.
11. Pin-replacement Kit		Replace circuit board connector pins	Tektronix Part Number 040-0542-01.
12. IC-Removal Tool		Removing DIP IC packages.	Augat T114-1.
13. Isopropyl Alcohol	Reagent grade.	Cleaning attenuator and front panel assemblies.	2-Isopropanol.

INTERCONNECTIONS

Interconnection in this instrument are made with pins soldered onto the circuit boards. Several types of mating connectors are used for the interconnecting pins. The following information provides the replacement procedures for the various type connectors.

End-Lead Pin Connectors

Pin connectors used to connect the wires to the interconnect pins are factory assembled. They consist of machine-inserted pin connectors mounted in plastic holders. If the connectors are faulty, the entire wire assembly should be replaced.

Multipin Connectors

When pin connectors are grouped together and mounted in a plastic holder, they are removed, reinstalled, or replaced as a unit. If any individual wire or connector in the assembly is faulty, the entire cable assembly should be replaced. To provide correct orientation of a multipin connector, an index arrow is stamped on the circuit board, and either a matching arrow is molded into or the numeral 1 is marked on the plastic housing as a matching index. Be sure these index marks are aligned with each other when the multipin connector is reinstalled.

TRANSISTORS, INTEGRATED CIRCUITS, AND HYBRID CIRCUITS

Transistors, integrated circuits, and hybrid circuits should not be replaced unless they are actually defective. If removed from their sockets or unsoldered from the circuit board during routine maintenance, return them to their original board locations. Unnecessary replacement or transposing of semiconductor devices may affect the adjustment of the instrument. When a semiconductor is replaced, check the performance of any circuit that may be affected.

Any replacement component should be of the original type or a direct replacement. Bend transistor leads to fit their circuit board holes, and cut the leads to the same length as the original component. See Figure 9-2 in the "Diagrams" section for lead-configuration illustrations.

The heat-sink-mounted power supply transistors are insulated from the heat sink with a heat-transferring insulator pad. Reinstall the insulator pads and bushings when replacing these transistors. Do not use any type of heat-transferring compound on the insulator pads.

NOTE

After replacing a power transistor, check that the collector is not shorted to the heat sink before applying power to the instrument.

To remove socketed dual-in-line packaged (DIP) integrated circuits, pull slowly and evenly on both ends of the device. Avoid disengaging one end of the integrated circuit from the socket before the other, since this may damage the pins.

To remove a soldered DIP IC when it is going to be replaced, clip all the leads of the device and remove the leads from the circuit board one at a time. If the device must be removed intact for possible reinstallation, do not heat adjacent conductors consecutively. Apply heat to pins at alter-

nate sides and ends of the IC as solder is removed. Allow a moment for the circuit board to cool before proceeding to the next pin.

Hybrid circuits and heatsinks are removed as a unit by removing the mounting nuts at the four corners of the heatsink/housing. A firm downward pressure at the center of the housing will aid in removal of the nuts. The hybrid circuit substrate is bonded to the heatsink/housing casting. Attempting to separate the hybrid device from its housing will damage the device.

SOLDERING TECHNIQUES

The reliability and accuracy of this instrument can be maintained only if proper soldering techniques are used to remove or replace parts. General soldering techniques, which apply to maintenance of any precision electronic equipment, should be used when working on this instrument.

WARNING

To avoid an electric-shock hazard, observe the following precautions before attempting any soldering: turn the instrument off, disconnect it from the ac power source, and verify that the line-rectifier filter capacitors have discharged. (See label on the primary power shield.) If, due to a component failure, the capacitors are not discharging, it may be necessary to discharge them. Use a 1 k Ω , 5-watt resistor and discharge the capacitors from point to point through the access holes in the primary power shield.

Use rosin-core wire solder containing 63% tin and 37% lead. Contact your local Tektronix Field Office or representative to obtain the names of approved solder types.

When soldering on circuits boards or small insulated wires, use only a 15-watt, pencil-type soldering iron. A higher wattage soldering iron may cause etched circuit conductors to separate from the board base material and melt the insulation on small wires. Always keep the soldering-iron tip properly tinned to ensure best heat transfer from the iron tip to the solder joint. Apply only enough solder to make a firm joint. After soldering, clean the area around the solder connection with an approved flux-removing solvent (such as isopropyl alcohol) and allow it to air dry.

Circuit boards in this instrument may have as many as four conductive layers. Conductive paths between the top and bottom board layers may connect to one or more inner

layers. If any inner-layer conductive path becomes broken due to poor soldering practices, the board becomes unusable and must be replaced. Damage of this nature can void the instrument warranty.

CAUTION

Only an experienced maintenance person, proficient in the use of vacuum-type desoldering equipment should attempt repair of any circuit board in this instrument.

Desoldering parts from multilayer circuit boards is especially critical. Many integrated circuits are static sensitive and may be damaged by solder extractors that generate static charges. Perform work involving static-sensitive devices only at a static-free work station while wearing a grounded antistatic wrist strap. Use only an antistatic vacuum-type solder extractor approved by a Tektronix Service Center.

CAUTION

Attempts to unsolder, remove, and resolder leads from the component side of a circuit board may cause damage to the reverse side of the circuit board.

The following techniques should be used to replace a component on a circuit board:

1. Touch the vacuum desoldering tool to the lead at the solder connection. Never place the iron directly on the board; doing so may damage the board.

NOTE

Some components are difficult to remove from the circuit board due to a bend placed in the component leads during machine insertion. To make removal of machine-inserted components easier, straighten the component leads on the reverse side of the circuit board.

2. When removing a multipin component, especially an IC, do not heat adjacent pins consecutively. Apply heat to the pins at alternate sides and ends of the IC as solder is removed. Allow a moment for the circuit board to cool before proceeding to the next pin.

CAUTION

Excessive heat can cause the etched circuit conductors to separate from the circuit board. Never allow the solder extractor tip to remain at one place on the board for more than three seconds. Solder wick, spring-actuated or squeeze-bulb solder suckers, and heat blocks (for desoldering multipin components) must not be used. Damage caused by poor soldering techniques can void the instrument warranty.

3. Bend the leads of the replacement component to fit the holes in the circuit board. If the component is replaced while the board is installed in the instrument, cut the leads so they protrude only a small amount through the reverse side of the circuit board. Excess lead length may cause shorting to other conductive parts.

4. Insert the leads into the holes of the board so that the replacement component is positioned the same as the original component. Most components should be firmly seated against the circuit board.

5. Touch the soldering iron to the connection and apply enough solder to make a firm solder joint. Do not move the component while the solder hardens.

6. Cut off any excess lead protruding through the circuit board (if not clipped to the correct length in step 3).

7. Clean the area around the solder connection with an approved flux-removing solvent. Be careful not to remove any of the printed information from the circuit board.

8. When soldering to the ceramic crt-termination network, a slightly larger soldering iron can be used. It is recommended that a solder containing about 3% silver be used when soldering to the ceramic material to avoid destroying the bond. The bond can be broken by repeated use of ordinary tin-lead solder or by the application of too much heat; however, occasional use of ordinary solder will not break the bond, provided excessive heat is not applied when making the connection.

REMOVAL AND REPLACEMENT INSTRUCTIONS

WARNING

To avoid electric shock, disconnect the instrument from the ac power source before removing or replacing any component or assembly.

The exploded view drawing in the "Replaceable Mechanical Parts" list at the rear of this manual may be helpful during the removal and reinstallation of individual components or subassemblies. Circuit board and component locations are illustrated in the "Diagrams" section of this manual.

Cabinet Removal

Removal of the instrument wrap-around cabinet is accomplished by the following steps:

1. Unplug the power cord from the ac power source.
2. Unplug the power cord from the rear-panel connector.
3. Install the front-panel cover, place the cabinet handle against the bottom of the cabinet, and set the instrument face down on a flat surface.
4. Unwrap the power cord from the instrument feet.
5. Remove the four screws in the rear-panel feet (see Figure 6-2).
6. Remove the two screws from the top-center and bottom-center of the rear panel (see Figure 6-2).
7. Lift the rear panel and power cord away from the instrument, leaving the rear-panel feet attached.

WARNING

Dangerous potentials exist at several points throughout this instrument. If it is operated with the cabinet removed, do not touch exposed connections or components. Some transistors may have elevated case voltages. Disconnect the ac power source from the instrument and verify that the line-rectifier filter capacitors have discharged before cleaning the instrument or replacing parts (see label on the primary power shield).

8. Slide the cabinet off of the instrument.

To reinstall the wrap-around cabinet, perform the reverse of the preceding instructions. Ensure that the cabinet fits properly into the emi gasket grooves in the front frame and rear panel.

WARNING

The line-rectifier filter capacitors normally retain a charge for a short period (approximately 15 to 20 seconds) after the instrument is turned off and can remain charged for a longer period if a bleeder-resistor or power-supply problem occurs. Before beginning any cleaning or work on the internal circuitry of the oscilloscope, disconnect the ac power source from the instrument and verify that the capacitors have discharged to 24 V or less. Measurement is made at the three points indicated on the plastic primary input shield at the rear of the instrument (after the Top-Cover Plate is removed). If the capacitors retain charges of greater than 24 V for more than 20 seconds, discharge them using a 1 k Ω , 5-watt resistor connected point-to-point across the capacitors (through the access holes). Ensure that the capacitors are discharged before commencing troubleshooting.

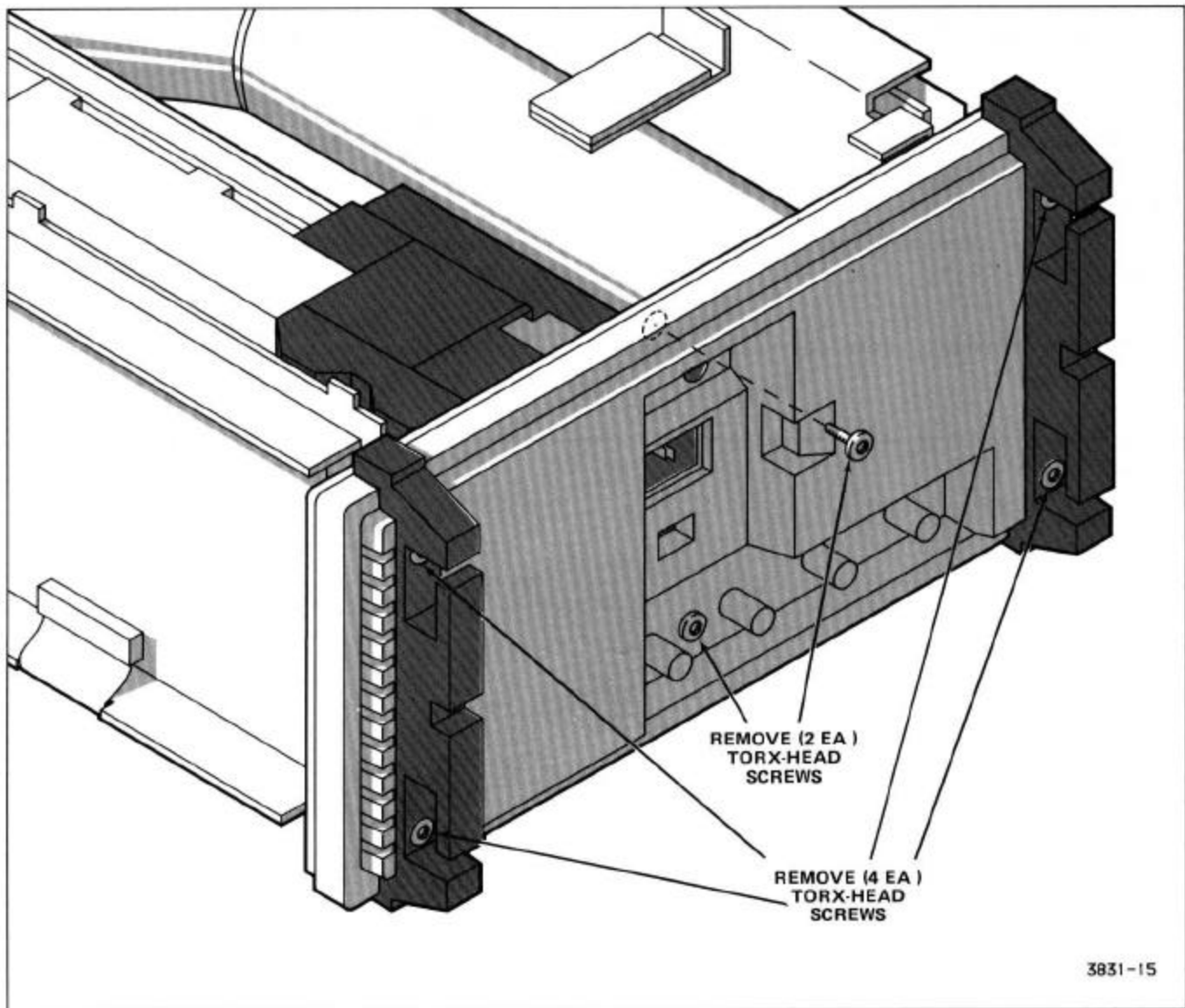

Figure 6-2. Rear panel removal.

Top-Cover Plate Removal

Removal of the Top-Cover Plate is accomplished by the following steps:

1. Remove the instrument cabinet as described in that procedure.
2. Set the instrument, bottom down, on a flat surface.
3. Remove the two securing screws from the top edge of the rear-panel chassis.
4. Remove the securing screw from the left side of the chassis.
5. Remove the two top securing screws at the front edge of the cover plate.
6. Remove the top securing nut at the rear of the cover plate.
7. Lift the Top-Cover Plate up and away from the instrument.

Maintenance—2445 Service

To reinstall the Top-Cover Plate, perform the reverse of the preceding instructions.

A5—Control Board Removal

Removal of the Control Board is accomplished by the following steps:

1. Remove the instrument wrap-around cabinet as described in that procedure.

2. Place the instrument on its left side on a flat surface.

3. Disconnect the three ribbon-cable connectors from the Control board (P251, P651, and P652) (see Figure 6-3).

4. Disconnect the two ribbon-cable connectors from the Main board (P511 and P512).

5. Remove the five mounting screws securing the board to the chassis, one at each corner of the board and one at the center.

6. Lift the Control board away from the chassis.

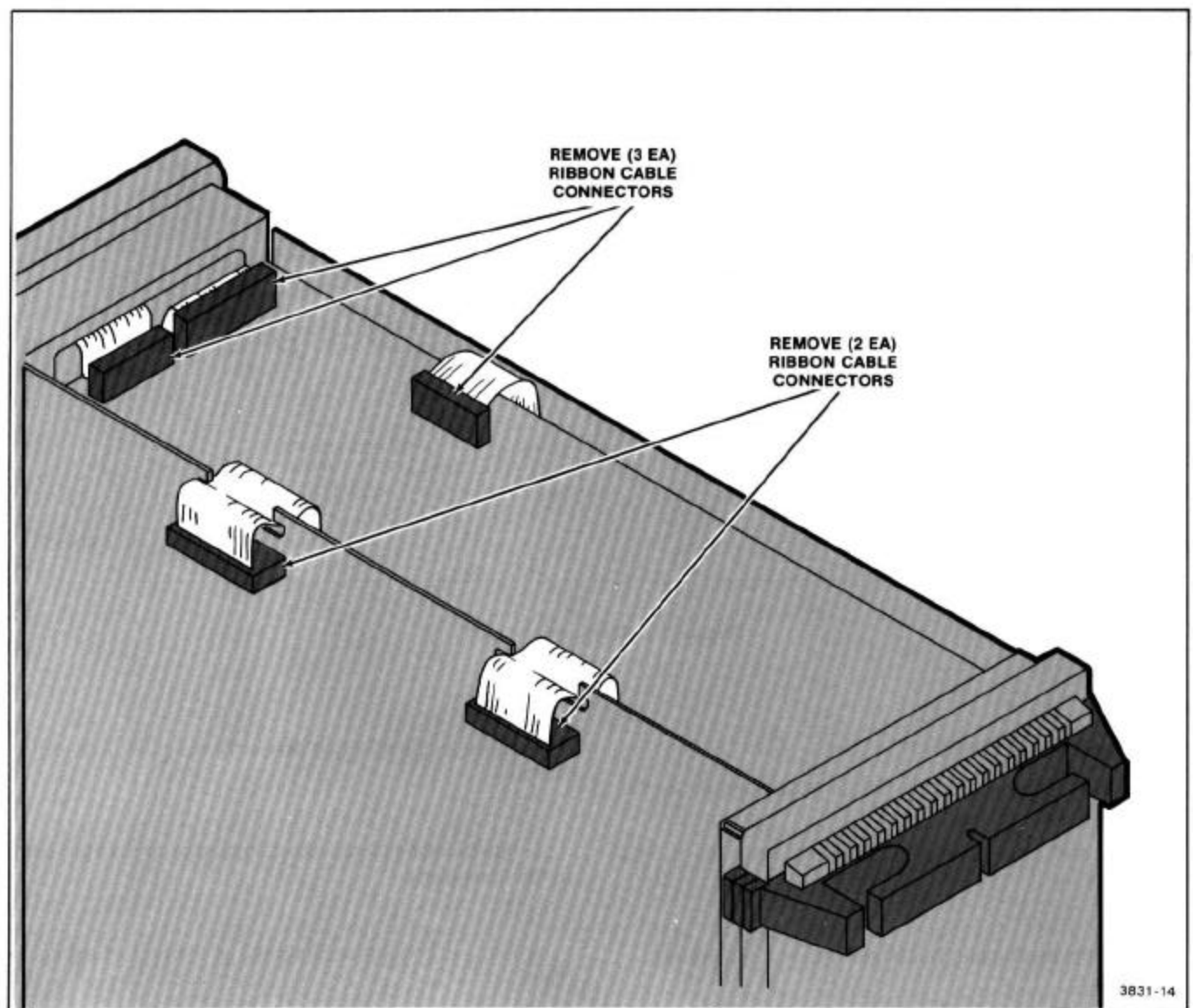

Figure 6-3. Ribbon cable removal.

To reinstall the Control board, perform the reverse of the preceding instructions.

A2, A3, and A12—Power Supply Assembly Removal

Removal of the Power Supply assembly is accomplished by the following steps:

1. Remove the instrument Cabinet as described in that procedure.
2. Remove the Top-Cover Plate as described in that procedure.
3. Loosen, but do not remove, the nut securing the fan blade to the fan motor shaft (a 1/4-inch nut driver is required).
4. Grasp the fan blade and, using firm pressure, pull the fan blade and mounting collar from the motor shaft.
5. Remove the two rear-panel screws holding the plastic primary circuit shield and remove the shield.
6. Remove the two screws holding the rear of the Power Supply assembly to the rear panel.
7. Remove the three screws securing the power-transistor heatsink to the chassis.
8. Disconnect the power supply ribbon-cable connector from the Control board (P251) and feed the cable through the slot in the Control board.
9. Disconnect the two power supply multipin connectors from the Power Supply assembly to the Main board (P121 and P122).
10. Disconnect the four primary power connections at the rear of the supply assembly (P204, P205, P206, and P207). Note their orientation for reinstallation.
11. If the Probe Power option is installed, disconnect the Probe Power connectors from the Power Supply assembly (P201 and P202).
12. Lift the Power Supply assembly from the instrument.

To reinstall the Power Supply assembly, perform the reverse of the preceding instructions.

The following procedures describe the further disassembly of the Power Supply circuit boards once the assembly is removed from the instrument.

FAN REMOVAL. To remove the Fan board and motor from the Power Supply assembly, perform the following steps:

1. Loosen the four screws on the plastic motor mount.
2. Disconnect the multipin connector from the Fan board (P301). Note the connector orientation for reinstallation.
3. Slide the Fan board and motor from the motor mount.

To reinstall the Fan board and motor, perform the reverse of the preceding steps.

INVERTER BOARD AND REGULATOR BOARD SEPARATION. To separate the Inverter and Regulator boards, perform the following steps:

1. Remove the rear-corner securing screw from the Regulator board.
2. Unplug the four thru-pin connectors (J231, J232, J233, and J234).
3. Separate the two circuit boards by unclipping the plastic edge connectors.

To rejoin the Inverter and Regulator boards, perform the reverse of the preceding steps.

A9—High-Voltage Board Removal

Removal of the High-Voltage board is accomplished by the following steps:

1. Remove the instrument Cabinet as described in that procedure.
2. Remove the Top-Cover Plate as described in that procedure.

WARNING

The crt anode lead may retain a high-voltage charge after the instrument is turned off. To avoid electrical shock, ground the crt anode lead to the chassis after disconnecting the plug. Reconnect and disconnect the anode-lead plug several time, grounding the anode lead to chassis ground each time it is disconnected to fully dissipate the charge.

3. Unplug the CRT anode lead and discharge it to chassis ground.

4. Unplug the two leads from the ceramic termination strip to the crt. Use long-nose pliers to pull the connectors straight away from the crt neck pins. Avoid putting excessive pressure on the metal-to-glass seal. Raise the connectors high enough to allow clearance for the crt anode lead (in step 7).

5. Disconnect the single conductor connector from the ceramic termination strip.

6. Remove the screw retaining the high-voltage lead clamp.

7. Slide the high-voltage lead sideways under the termination strip.

8. Loosen the two screws on the left side of the crt socket cover and remove the one on the right side. Remove the cover.

9. Remove the five screws securing the High-Voltage board shield to remove the shield.

10. Remove the four mounting posts securing the High-Voltage board to the chassis.

11. Unplug the crt socket by gently prying evenly on both sides of the socket until the socket can be disengaged from the crt pins. Do not apply excessive side pressure on the socket.

12. Disconnect the two multipin connectors and one single-conductor connector from the front of the High-Voltage board (P902, P903, and P904). Note orientation for reinstallation.

13. Tilt the top of the board out to clear the left-side frame and pull the board up to disengage the High-Voltage board pin connectors from the Main board.

14. Lift the board from the chassis while carefully feeding the crt socket, cabling, and high-voltage lead through the chassis slot.

To reinstall the High-Voltage board, perform the reverse of the preceding instructions.

A4—Readout Board Removal

Removal of the Readout board is accomplished by the following steps:

1. Remove the instrument Cabinet as described in that procedure.

2. Remove the Top-Cover Plate as described in that procedure.

3. Place the instrument, left side down, on a flat surface.

4. Disconnect the Readout Board ribbon-cable connector from the Main board (P411).

5. With the instrument still on its side, pull the circuit board out of its plastic board mounts. Remove the board from the instrument while guiding the ribbon cable and connector through the slots in the Main board and chassis.

To reinstall the Readout board, perform the reverse of the preceding steps.

A6 and A7—Front-Panel and Variable Board Assembly Removal

Removal of the Front-Panel and Variable board assembly is accomplished by the following steps:

1. Remove the instrument Cabinet as described in that procedure.

2. Using a small-bladed screwdriver, pry the trim strip from the top edge of the front-panel trim ring. Gently pry up on the back edge to release it, then pry gently at each of the front edge retaining clips to remove the strip.

3. Remove the five screws from the top edge of the front-panel trim ring.

4. Remove the four screws and the two plastic feet from the bottom edge of the front-panel trim ring.

5. Remove the screw from either side of the front-panel trim ring (screws are recessed in the front-cover catches).

6. Using firm pressure, pull the knobs from the four controls directly below the crt (INTENSITY, FOCUS, READOUT INTENSITY, and SCALE ILLUM).

7. Slide off the front-panel trim ring and outer crt bezel.

8. Disconnect the two ribbon-cable connectors from the front edge of the Control board (P651 and P652).

9. Pull out the Front-Panel and Variable board assembly.

The following steps describe the further disassembly of the Front-Panel and Variable boards once the assembly is removed from the instrument.

ASSEMBLY SEPARATION. Separation of the Variable board from the Front-Panel board is accomplished by the following steps:

1. Using a 1/16-inch Allen wrench, loosen the set screws in the CH 1 VOLTS/DIV VAR, CH 2 VOLTS/DIV VAR, and A and B SEC/DIV VAR knobs and remove the knobs from their control shafts.

2. Disconnect the multipin connector from the Variable board (P671).

3. Remove the two screws securing the Variable board to the mounting posts.

4. Slide the Variable board and the variable-control shafts away from the Front-Panel board.

FRONT-PANEL COVER PLATE REMOVAL. Use the following procedure to remove the front-panel cover plate from the Front-Panel board.

1. Separate the Front-Panel and Variable boards as described above (if not already done).

2. Using a 1/16-inch Allen wrench, loosen the set screws in the CH 1 and CH 2 VOLTS/DIV knobs. Remove the knobs from their control shafts (if not previously removed).

3. Pull the B SEC/DIV knob to the out position to gain access to the two recessed setscrews.

4. Use a 1/16-inch Allen wrench to loosen the two setscrews and remove the B SEC/DIV knob.

5. Loosen the setscrews in the A SEC/DIV collar and remove the collar.

6. Using firm outward pressure, pull the knobs off of the Vertical and Horizontal POSITION controls, the Trigger HOLDOFF and LEVEL controls, the Delta controls, and the TRACE SEP control (ten knobs). Note the differences in the knobs for reinstallation.

7. Remove the three securing screws and two securing studs from the rear of Front-Panel board.

8. Partially separate the board from the front-panel cover plate to expose the B SEC/DIV knob microswitch and multipin connector.

9. Unplug the connector (P601) from the Front-Panel board and separate the board from the cover plate.

To reinstall the Front-Panel and Variable board assembly, perform the reverse of the preceding instructions.

A10 and A11—Channel 1 and Channel 2 Attenuator Assembly Removal

Removal of either the Channel 1 or Channel 2 Attenuator assembly is accomplished by the following steps:

1. Remove the instrument Cabinet as described in that procedure.

2. Remove the Front-Panel and Variable board assembly as described in that procedure.

3. Remove the two screws holding the small mounting bracket under the Attenuator assemblies and remove the bracket.

Maintenance—2445 Service

4. Remove the two screws that hold the Attenuator being removed to the front-panel frame.

5. Remove the two mounting screws holding the Attenuator being removed to the Main board (through access holes in the front-panel compartment).

6. Disconnect the associated multipin connector from the Main board (either P10 for Channel 1 or P11 for Channel 2).

7. Remove the two screws holding the rear attenuator shield and remove the shield.

8. Unsolder the two Attenuator output leads and the compensation capacitor lead.

9. Unplug the Attenuator by gently pulling the assembly straight up and away from the Main board.

To reinstall a removed Attenuator assembly, perform the reverse of the preceding steps.

A1—Main Board Removal

Removal of the Main board is accomplished by the following steps:

1. Remove the instrument Cabinet as described in that procedure.

2. Remove the Top-Cover Plate as described in that procedure.

3. Remove the Front-Panel and Variable board assembly as described in that procedure.

4. Disconnect the two power-supply multipin connectors from the power supply Regulator board (P121 and P122).

5. Disconnect the three ribbon-cable connections from the bottom of the Main board (P411, P511, and P512).

6. Disconnect the vertical and horizontal deflection leads from the crt neck pins. Access is via holes in the Main board. Use long-nose pliers to disconnect the pins by gently pulling straight up on the connectors. Avoid putting excessive side pressure on the metal-to-glass seal of the crt neck pins.

7. Disconnect the rear-panel BNC connector leads from the rear of the Main Board (P106, P107, and P108).

8. Disconnect the CH 2 OUT connector from near the center of the Main board (P105)

9. Disconnect the six multipin connectors for the controls beneath the crt (P111, P112, P113, P114, P115, and P116).

10. Disconnect the two-conductor connector for the Scale Illumination board from between the ASTIG and the SCALE ILLUM control connections (P181).

11. Unsnap the Power-switch rod from the switch hinge at the rear of the instrument by applying counterclockwise torque to the shaft and sliding it out of the hinge.

12. Remove the Power-switch push-button mounting screw from the front of the instrument (on the bottom of the front frame) and extract the Power-switch rod.

13. Remove the two screws holding the small bracket under the Attenuator assemblies and remove the bracket.

14. Remove the six screws holding the Attenuator assemblies and the CH 3 and CH 4 input connectors to the front frame.

15. Remove the Main board mounting screws (eleven screws total securing the Main board to the frame).

16. Raise the rear of the Main board to unplug J191 and separate the Main board from the HV board. When the plug pins are completely disengaged and the rear of the board clears the rear frame, slide the Main board rearward out of the front-panel frame.

17. Lift the Main board and Delay Line clear of the instrument while working the power supply cables through the slot in the frame.

To reinstall the Main board, perform the reverse of the preceding instructions.

A8—Scale Illumination Board Removal

Removal of the Scale-Illumination board is accomplished by the following steps:

1. Remove the instrument Cabinet as described in that procedure.

2. Remove the front-panel trim and outer crt bezel as described in the Front-Panel and Variable board assembly removal instructions.

3. Remove the eight screws holding the crt mounting bezel in place and remove the bezel and plastic gasket. Note the length difference in the screws for reinstallation.

4. Remove the plastic lens from the Scale-Illumination board.

5. Disconnect the scale-illumination multipin connector from the Main board (P181).

6. Remove the Scale-Illumination board by lifting it away from the front frame while working the wires and connector through the slot in the frame.

To reinstall the Scale-Illumination board, perform the reverse of the preceding instructions.

CRT Removal

WARNING

Use care when handling a crt. Breakage of the crt may cause high-velocity scattering of glass fragments (implosion). Protective clothing and safety glasses (preferably a full-face shield) should be worn. Avoid striking the crt on any object which may cause it to crack or implode. When storing a crt, place it in a protective carton or set it face down on a smooth surface in a protected location. When stored face down, it should be placed on a soft, nonabrasive surface to prevent the crt face plate from being scratched.

1. Remove the instrument Cabinet as described in that procedure.

2. Remove the Top-Cover Plate as described in that procedure.

3. Loosen the two screws on the left side of the crt socket cover and remove the one on the right side. Remove the cover.

4. Unplug the crt socket by gently prying the socket evenly on both sides until the pins can be disengaged. Do not apply excessive side pressure on the socket as it is being removed.

WARNING

The crt anode lead and the output terminal of the High-Voltage Multiplier can retain a high-voltage charge after the instrument is turned off. To avoid electrical shock, ground both the crt anode lead and the high-voltage lead to the main instrument chassis. Repeat the grounding process several times to fully dissipate the charge.

5. Disconnect the crt anode lead connector and discharge it to chassis ground.

6. Using long-nosed pliers, disconnect the horizontal and vertical deflection leads from the bottom of the crt. Pull straight out on these connectors to prevent excessive strain on the metal-to-glass seal. (Access to the connectors is through holes in the Main board).

7. Using long-nosed pliers, disconnect the vertical termination leads from the top of the crt.

8. Using long-nosed pliers, disconnect the crt shield resistor from the top of the crt.

9. Disconnect the Y-Axis Alignment coil connector from the front of the High-Voltage board (P903).

10. Remove the front-panel trim ring and outer crt bezel as described in the Front-Panel and Variable board assembly removal instructions.

11. Remove the eight retaining screws from the crt-mounting bezel at the front of the crt. Note the difference in length of the screws for reinstallation.

12. Remove the crt mounting bezel and plastic gasket from the crt.

Maintenance—2445 Service

13. Slide the crt forward slightly by gently pushing on the rear of the crt neck until the front of the crt can be grasped.

14. Slide the crt out of the instrument while feeding the anode lead and Y-Axis Alignment coil leads through their respective holes.

NOTE

Once the crt is removed, it should be stored in such a manner as to protect it from impact. If stored face down, it should be placed on a soft, nonabrasive surface to prevent the crt face plate from being scratched. To reinstall the crt, perform the reverse of the preceding instructions.

OPTIONS

INTRODUCTION

This section contains a general description of instrument options available at the time of publication of this manual. Additional information about instrument options and option availability can be obtained either by consulting the current Tektronix Product Catalog or by contacting your local Tektronix Field Office or representative.

OPTION 22

When ordered with this option, two additional probe packages identical to the standard-accessory probes are supplied with the instrument.

OPTION 1R

When the 2445 Oscilloscope is ordered with Option 1R, it is shipped in a configuration that permits easy installation into a 19-inch-wide electronic-equipment rack.

An optional rear-support kit is also available for use when rackmounting the 2445. Using this optional rear-support kit enables the rackmounted instrument to meet or exceed the requirements of MIL-T-28800C with respect to Type III, Class 5, Style C electronic equipment for vibration and shock. Other electrical and environmental specifications of the 2445 apply to both the rackmounted and the standard instrument with one exception. For the rackmounted instrument, the ambient air temperature operating limits (-15°C to $+55^{\circ}\text{C}$) are measured at the instrument's air inlet, and its fan exhaust air temperature should not be allowed to exceed $+65^{\circ}\text{C}$.

Connector-mounting holes are provided in the rack-mount front panel. These holes enable convenient accessing of the four BNC connectors (CH 2 SIGNAL OUT, A GATE OUT, B GATE OUT, and EXT Z AXIS IN) located on the rear panel. Additional cabling and connectors required to implement any front-panel access to the rear-panel connectors are supplied by the user; however, these items can be separately ordered from Tektronix.

Complete rackmounting instructions are provided in a separate document shipped with the 2445 Option 1R. These instructions also contain appropriate procedures to convert a standard instrument into the Option 1R configuration by using the rackmounting conversion kit.

POWER CORD OPTIONS

Instruments are shipped with the detachable-power-cord configuration ordered by the customer. Descriptive information about the international power-cord options is provided in Section 2, "Operating Information." The following list identifies the Tektronix part numbers for the available power cords and associated fuses.

Option A1 (Universal Euro)

Power cord (2.5 m)	161-0104-06
Fuse (1.6 A, 250 V, 5 x 20 mm, Quick-acting)	159-0098-00
Fuse cap	200-2265-00

Option A2 (UK)

Power cord (2.5 m)	161-0104-07
Fuse (1.6 A, 250 V, 5 x 20 mm, Quick-acting)	159-0098-00
Fuse cap	200-2265-00

Option A3 (Australian)

Power cord (2.5 m)	161-0104-05
Fuse (1.6 A, 250 V, 5 x 20 mm, Quick-acting)	159-0098-00
Fuse cap	200-2265-00

Option A4 (North American)

Power cord (2.5 m)	161-0104-08
Fuse (2 A, 250 V, AGC/3AG, Fast-blow)	159-0021-00
Fuse cap	200-2264-00

Options—2445 Service

Option A5 (Switzerland)

Power cord (2.5 m)	161-0167-00
Fuse (1.6 A, 250 V, 5 x 20 mm, Quick-acting)	159-0098-00
Fuse cap	200-2265-00

FUTURE OPTIONS

Technical documentation for options not available at the time of publication of this manual will be supplied in separate Operators and Service manuals for each option.

REPLACEABLE ELECTRICAL PARTS

PARTS ORDERING INFORMATION

Replacement parts are available from or through your local Tektronix, Inc. Field Office or representative.

Changes to Tektronix instruments are sometimes made to accommodate improved components as they become available, and to give you the benefit of the latest circuit improvements developed in our engineering department. It is therefore important, when ordering parts, to include the following information in your order: Part number, instrument type or number, serial number, and modification number if applicable.

If a part you have ordered has been replaced with a new or improved part, your local Tektronix, Inc. Field Office or representative will contact you concerning any change in part number.

Change information, if any, is located at the rear of this manual.

LIST OF ASSEMBLIES

A list of assemblies can be found at the beginning of the Electrical Parts List. The assemblies are listed in numerical order. When the complete component number of a part is known, this list will identify the assembly in which the part is located.

CROSS INDEX-MFR. CODE NUMBER TO MANUFACTURER

The Mfr. Code Number to Manufacturer index for the Electrical Parts List is located immediately after this page. The Cross Index provides codes, names and addresses of manufacturers of components listed in the Electrical Parts List.

ABBREVIATIONS

Abbreviations conform to American National Standard Y1.1.

COMPONENT NUMBER (column one of the Electrical Parts List)

A numbering method has been used to identify assemblies, subassemblies and parts. Examples of this numbering method and typical expansions are illustrated by the following:

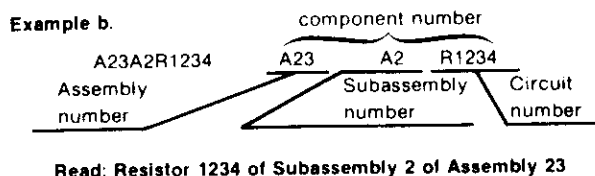
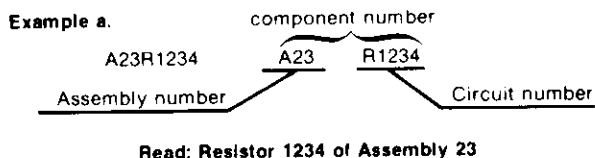

Only the circuit number will appear on the diagrams and circuit board illustrations. Each diagram and circuit board illustration is clearly marked with the assembly number. Assembly numbers are also marked on the mechanical exploded views located in the Mechanical Parts List. The component number is obtained by adding the assembly number prefix to the circuit number.

The Electrical Parts List is divided and arranged by assemblies in numerical sequence (e.g., assembly A1 with its subassemblies and parts, precedes assembly A2 with its subassemblies and parts).

Chassis-mounted parts have no assembly number prefix and are located at the end of the Electrical Parts List.

TEKTRONIX PART NO. (column two of the Electrical Parts List)

Indicates part number to be used when ordering replacement part from Tektronix.

SERIAL/MODEL NO. (columns three and four of the Electrical Parts List)

Column three (3) indicates the serial number at which the part was first used. Column four (4) indicates the serial number at which the part was removed. No serial number entered indicates part is good for all serial numbers.

NAME & DESCRIPTION (column five of the Electrical Parts List)

In the Parts List, an Item Name is separated from the description by a colon (:). Because of space limitations, an Item Name may sometimes appear as incomplete. For further Item Name identification, the U.S. Federal Cataloging Handbook H6-1 can be utilized where possible.

MFR. CODE (column six of the Electrical Parts List)

Indicates the code number of the actual manufacturer of the part. (Code to name and address cross reference can be found immediately after this page.)

MFR. PART NUMBER (column seven of the Electrical Parts List)

Indicates actual manufacturers part number.

Replaceable Electrical Parts—2445 Service

CROSS INDEX—MFR. CODE NUMBER TO MANUFACTURER

Mfr. Code	Manufacturer	Address	City, State, Zip
000FG	RIFA WORLD PRODUCTS INC.	7625 BUSH LAKE RD P.O. BOX 35263	MINNEAPOLIS, MN 55435
000FJ	MARCOM SWITCHES INC.	67 ALBANY STREET	CAZENOVIA, N.Y. 13035
000HX	SAN-O INDUSTRIAL CORP.	170 WILBUR PLACE	BAHEMIA LONG ISLAND, NY 11716
000IG	FUJITSU-AMERICA INC.	1208 E. ARQUES AVE.	SUNNYVALE, CA 94086
000JF	FUJI SEMICONDUCTOR	NEW YURAKUCHO BLDG	TOKYO 100, JAPAN
00213	NYTRONICS, COMPONENTS GROUP, INC., SUBSIDIARY OF NYTRONICS, INC.	ORANGE STREET	DARLINGTON, SC 29532
00779	AMP, INC.	P.O. BOX 3608	HARRISBURG, PA 17105
01121	ALLEN-BRADLEY COMPANY	1201 2ND STREET SOUTH	MILWAUKEE, WI 53204
01295	TEXAS INSTRUMENTS, INC. SEMICONDUCTOR GROUP	P.O. BOX 5012	DALLAS, TX 75222
02113	COILCRAFT INC.	1102 SILVER LAKE RD.	CARY, IL 60013
02735	RCA CORPORATION, SOLID STATE DIVISION	ROUTE 202	SOMERVILLE, NY 08876
03508	GENERAL ELECTRIC COMPANY, SEMI-CONDUCTOR PRODUCTS DEPARTMENT	ELECTRONICS PARK P O BOX 867	SYRACUSE, NY 13201
04222	AVX CERAMICS, DIVISION OF AVX CORP.	5005 E MCDOWELL RD, PO BOX 20923	MYRTLE BEACH, SC 29577
04713	MOTOROLA, INC., SEMICONDUCTOR PROD. DIV.		PHOENIX, AZ 85036
07263	FAIRCHILD SEMICONDUCTOR, A DIV. OF FAIRCHILD CAMERA AND INSTRUMENT CORP.	464 ELLIS STREET RICHARDS AVENUE	MOUNTAIN VIEW, CA 94042
09922	BURNDY CORPORATION	LOWER WASHINGTON STREET	NORWALK, CT 06852
12697	CLAROSTAT MFG. CO., INC.	580 PLEASANT STREET	DOVER, NH 03820
12969	UNITRODE CORPORATION	3301 ELECTRONICS WAY P O BOX 3049	WATERTOWN, MA 02172
14433	ITT SEMICONDUCTORS	2830 E FAIRVIEW ST. 1710 S. DEL MAR AVE.	WEST PALM BEACH, FL 33402 SANTA ANA, CA 92704 SAN GABRIEL, CA 91776
14552	MICRO SEMICONDUCTOR CORP.		
14752	ELECTRO CUBE INC.		
15238	ITT SEMICONDUCTORS, A DIVISION OF INTER NATIONAL TELEPHONE AND TELEGRAPH CORP.	P.O. BOX 168, 500 BROADWAY	LAWRENCE, MA 01841
15454	RODAN INDUSTRIES, INC.	2905 BLUE STAR ST.	ANAHEIM, CA 92806
17856	SILICONIX, INC.	2201 LAURELWOOD DRIVE	SANTA CLARA, CA 95054
20462	PREM ENTERPRISES, INC.	3519 N. CHAPEL HILL	MCHENRY, IL 60050
20932	EMCON DIV OF ILLINOIS TOOL WORKS INC.	11620 SORRENTO VALLEY RD P O BOX 81542	SAN DIEGO, CA 92121
22526	BERG ELECTRONICS, INC.	YOUK EXPRESSWAY	NEW CUMBERLAND, PA 17070
22753	U. I. D. ELECTRONICS CORP.	4105 PEMBROKE RD.	HOLLYWOOD, FL 33021
24546	CORNING GLASS WORKS, ELECTRONIC COMPONENTS DIVISION	550 HIGH STREET	BRADFORD, PA 16701
25088	SIEMENS CORP.	186 WOOD AVE. S	ISELIN, NJ 08830
27014	NATIONAL SEMICONDUCTOR CORP.	2900 SEMICONDUCTOR DR.	SANTA CLARA, CA 95051
27264	MOLEX, INC.	2222 WELLINGTON COURT	LISLE, IL 60532
31918	IEE/SCHADOW INC.	8081 WALLACE ROAD	EDEN PRAIRIE, MN 55343
32159	WEST-CAP ARIZONA	2201 E. ELVIRA ROAD	TUCSON, AZ 85706
32997	BOURNS, INC., TRIMPOT PRODUCTS DIV.	1200 COLUMBIA AVE.	RIVERSIDE, CA 92507
34335	ADVANCED MICRO DEVICES	901 THOMPSON PL.	SUNNYVALE, CA 94086
34479	RENCO CORP	26 COROMAR DRIVE	GOLETA, CA 93117
50157	MIDWEST COMPONENTS INC.	P. O. BOX 787 1981 PORT CITY BLVD.	MUSKEGON, MI 49443
50434	HEWLETT-PACKARD COMPANY	640 PAGE MILL ROAD	PALO ALTO, CA 94304
54473	MATSUSHITA ELECTRIC, CORP. OF AMERICA	1 PANASONIC WAY	SECAUCUS, NJ 07094
54937	DEYOUNG MFG., INC.	PO BOX 1806, 1517 130TH AVE.	BELLEVUE, WA 98009
55112	PLESSEY CAPACITORS, DIV. OF PLESSEY INC.	5334 STERLING CENTER DR.	WEST LAKE VILLAGE, CA 91361
55680	NICHICON/AMERICA/CORP.	6435 N PROESEL AVENUE	CHICAGO, IL 60645
56289	SPRAGUE ELECTRIC CO.	87 MARSHALL ST.	NORTH ADAMS, MA 01247
57668	R-OHM CORP.	16931 MILLIKEN AVE.	IRVINE, CA 92713
59660	TUSONIX INC.	2155 N FORBES BLVD	TUCSON, AZ 85705
59821	CENTRALAB INC	7158 MERCHANT AVE	EL PASO, TX 79915
71400	SUB NORTH AMERICAN PHILIPS CORP BUSSMAN MFG., DIVISION OF MCGRAW- EDISON CO.	2536 W. UNIVERSITY ST. 644 W. 12TH ST.	ST. LOUIS, MO 63107 ERIE, PA 16512
72982	ERIE TECHNOLOGICAL PRODUCTS, INC.	2500 HARBOR BLVD.	FULLERTON, CA 92634
73138	BECKMAN INSTRUMENTS, INC., HELIPOT DIV.	1933 HECK AVE.	NEPTUNE, NJ 07753
74276	SIGNALITE DIV., GENERAL INSTRUMENT CORP.	299 10TH AVE. S. W.	WASECA, MN 56093
74970	JOHNSON, E. F., CO.		
75042	TRW ELECTRONIC COMPONENTS, IRC FIXED RESISTORS, PHILADELPHIA DIVISION	401 N. BROAD ST.	PHILADELPHIA, PA 19108
75915	LITTELFUSE, INC.	800 E. NORTHWEST HWY	DES PLAINES, IL 60016

CROSS INDEX—MFR. CODE NUMBER TO MANUFACTURER

Mfr. Code	Manufacturer	Address	City, State, Zip
76493	BELL INDUSTRIES, INC., MILLER, J. W., DIV.	19070 REYES AVE., P O BOX 5825	COMPTON, CA 90224
76784	OAK SWITCH SYSTEMS INC SUB OF OAK TECHNOLOGY INC	100 S MAIN ST S. MAIN ST.	CRYSTAL LAKE, IL 60014 CRYSTAL LAKE, IL 60014
76854	OAK INDUSTRIES, INC., SWITCH DIV.	P O BOX 500	BEAVERTON, OR 97077
80009	TEKTRONIX, INC.	22 COLUMBIA ROAD	MORRISTOWN, NJ 07960
80031	ELECTRA-MIDLAND CORP., MEPCO DIV.	9220 SUNSET BLVD.	LOS ANGELES, CA 90069
81483	INTERNATIONAL RECTIFIER CORP.	112 W. FIRST ST.	OGALLALA, NE 69153
84411	TRW ELECTRONIC COMPONENTS, TRW CAPACITORS	3029 E. WASHINGTON STREET	
90201	MALLORY CAPACITOR CO., DIV. OF P. R. MALLORY AND CO., INC.	P. O. BOX 372 P. O. BOX 609	INDIANAPOLIS, IN 46206 COLUMBUS, NE 68601
91637	DALE ELECTRONICS, INC.		
93410	ESSEX INTERNATIONAL, INC., CONTROLS DIV. LEXINGTON PLANT	P. O. BOX 1007	MANSFIELD, OH 44903
96733	SAN FERNANDO ELECTRIC MFG CO	1501 FIRST ST	SAN FERNANDO, CA 91341
T0875	MATSUO ELECTRONICS INC	831 S DOUGLAS STREET	EL SEGUNDO, CA 92641
T0900	UNITED CHEMI-CON	9801 W. HIGGINS ROAD	ROSEMONT, IL 60018
T0946	SAN-O INDUSTRIAL CORP.	170 WILBUR PL	BAHEMIA, LONG ISLAND, NY 1171

Replaceable Electrical Parts—2445 Service

Component No.	Tektronix Part No.	Serial/Model No. Eff	Dscont	Name & Description	Mfr Code	Mfr Part Number
A1	670-7285-00	B010100	B011399	CKT BOARD ASSY:MAIN	80009	670-7285-00
A1	-----			(STANDARD ONLY)		
A1	670-7285-04	B011400	B012499	CKT BOARD ASSY:MAIN	80009	670-7285-04
A1	-----			(STANDARD ONLY)		
A1	670-7285-07	B012500	B019999	CKT BOARD ASSY:MAIN	80009	670-7285-07
A1	-----			(STANDARD ONLY)		
A1	670-7285-08	B020000		CKT BOARD ASSY:	80009	670-7285-08
A1	-----			(STANDARD,OPT.10 ONLY)		
A1	670-7285-06	B020000		CKT BOARD ASSY:MAIN	80009	670-7285-06
A1	-----			(OPTS 01,05,06,09 OR 1B ONLY)		
	672-1037-00	B010100	B019999	CKT BOARD ASSY:LV/POWER SUPPLY MODULE	80009	672-1037-00
	672-1037-02	B020000		CKT BOARD ASSY:LV/POWER SUPPLY MODULE	80009	672-1037-02
A2	-----			CKT BOARD ASSY:REGULATOR		
A2	-----			(AVAILABLE AT 672-1037-XX LEVEL ONLY)		
A3	-----			CKT BOARD ASSY:INVERTER		
A3	-----			(AVAILABLE AT 672-1037-XX LEVEL ONLY)		
A4	670-7278-00			CKT BOARD ASSY:BUS READOUT	80009	670-7278-00
A5	670-7279-00	B010100	B013199	CKT BOARD ASSY:DIGITAL CONTROL	80009	670-7279-00
A5	670-7279-04	B013200		CKT BOARD ASSY:DIGITAL CONTROL	80009	670-7279-04
	672-1039-00	B010100	B014137	CKT BOARD ASSY:FRONT PANEL	80009	672-1039-00
	672-1039-00	B014138		CKT BOARD ASSY:FRONT PANEL	80009	672-1039-00
A6	-----			CKT BOARD ASSY:FRONT PANEL		
A6	-----			(AVAILABLE AT 672-1039-XX LEVEL ONLY)		
A7	670-7284-00			CKT BOARD ASSY:FRONT PANEL VARIABLE	80009	670-7284-00
A8	670-7280-00			CKT BOARD ASSY:SCALE ILLUMINATION	80009	670-7280-00
A9	670-7277-00	B010100	B010999	CKT BOARD ASSY:HIGH VOLTAGE	80009	670-7277-00
A9	670-7277-01	B011000	B012149	CKT BOARD ASSY:HIGH VOLTAGE	80009	670-7277-01
A9	670-7277-02	B012150	B013249	CKT BOARD ASSY:HIGH VOLTAGE	80009	670-7277-02
A9	670-7277-03	B013250	B013849	CKT BOARD ASSY:HIGH VOLTAGE	80009	670-7277-03
A9	670-7277-05	B013650		CKT BOARD ASSY:HIGH VOLTAGE	80009	670-7277-05
A10	670-7390-00			CKT BOARD ASSY:FAN MOTOR	80009	670-7390-00
A11	119-1445-01			ATTENUATOR,VAR:PROGRAMMABLE 1X-100X,CH1	80009	119-1445-01
A11	-----			(CHANNEL 1)		
A12	119-1445-02			ATTENUATOR,VAR:PROGRAMMABLE,1X-100X,CH2	80009	119-1445-02
A12	-----			(CHANNEL 2)		
A13	307-1154-00			PASSIVE NETWORK:CRT TERMINATOR,FINISHED	80009	307-1154-00
A14	670-8000-00			CKT BOARD ASSY:DYNAMIC CENTERING	80009	670-8000-00
A1	670-7285-00	B010100	B01139	CKT BOARD ASSY:MAIN	80009	670-7285-00
A1	-----			(STANDARD)		
A1	670-7285-04	B011400	B01249	CKT BOARD ASSY:MAIN	80009	670-7285-04
A1	-----			(STANDARD)		
A1	670-7285-07	B012500	B01999	CKT BOARD ASSY:MAIN	80009	670-7285-07
A1	-----			(STANDARD)		
A1	670-7285-08	B020000		CKT BOARD ASSY:	80009	670-7285-08
A1	-----			(STANDARD & OPT.10 ONLY)		
A1	670-7285-06	B020000		CKT BOARD ASSY:MAIN	80009	670-7285-06
A1	-----			(OPTS 01,05,09 OR 1B ONLY)		
A1C100	283-0000-00			CAP.,FXD,CER DI:0.001UF,+100-0%,500V	59660	831610Y5U0102P
A1C100	-----			(IN COMBO W/R100)		
A1C101	281-0812-00			CAP.,FXD,CER DI:1000PF,10%,100V	04222	MA101C102KAA
A1C102	290-0963-00	B010100	B010799	CAP.,FXD,ELCTL:220UF,+50-10%,25V	T0900	SM25VB220Q
A1C102	290-0973-00	B010800		CAP.,FXD,ELCTL: 100UF,25%,25VDC	55680	ORD BY DESCR

Replaceable Electrical Parts—2445 Service

Component No.	Tektronix Part No.	Serial/Model No. Eff	Dscont	Name & Description	Mfr Code	Mfr Part Number
A1C103	283-0492-00			CAP.,FXD,CER DI:100PF,20%	20932	501EM50DP10SM
A1C104	283-0000-00			CAP.,FXD,CER DI:0.001UF,+100-0%,500V	59660	831610Y5U0102P
A1C105	281-0064-00			CAP.,VAR,PLSTC:0.25-1.5PF,600V	74970	273-0001-101
A1C106	283-0024-00			CAP.,FXD,CER DI:0.1UF,+80-20%,50V	72982	8121N083Z5U0104Z
A1C107	290-0943-00			CAP.,FXD,ELCLT:47UF,+50-10%,25V	55680	ULB1E470TECANA
A1C108	283-0423-00			CAP.,FXD,CER DI:0.22UF,+80-20%,50V	04222	DG015E224Z
A1C113	283-0423-00			CAP.,FXD,CER DI:0.22UF,+80-20%,50V	04222	DG015E224Z
A1C114	290-0943-00			CAP.,FXD,ELCLT:47UF,+50-10%,25V	55680	ULB1E470TECANA
A1C115	281-0761-00			CAP.,FXD,CER DI:27PF,5%,100V	72982	314-008S2H270J
A1C116	281-0814-00			CAP.,FXD,CER DI:100PF,10%,100V	04222	GC101A101K
A1C117	283-0421-00	B020000		CAP.,FXD,CER DI:0.1UF,+80-20%,50V	04222	DG015E104Z
A1C118	281-0205-00			CAP.,VAR,PLSTC:5.5-65PF,100V	80031	2810C5R565QJ02F0
A1C119	283-0421-00			CAP.,FXD,CER DI:0.1UF,+80-20%,50V	04222	DG015E104Z
A1C120	283-0421-00			CAP.,FXD,CER DI:0.1UF,+80-20%,50V	04222	DG015E104Z
A1C121	290-0943-00			CAP.,FXD,ELCLT:47UF,+50-10%,25V	55680	ULB1E470TECANA
A1C122	283-0010-00			CAP.,FXD,CER DI:0.05UF,+100-20%,50V	56289	1C10Z5U503Z050B
A1C125	283-0421-00			CAP.,FXD,CER DI:0.1UF,+80-20%,50V	04222	DG015E104Z
A1C130	290-0776-00			CAP.,FXD,ELCLT:22UF,+50-10%,10V	55680	ULA1A220TEA
A1C175	283-0421-00			CAP.,FXD,CER DI:0.1UF,+80-20%,50V	04222	DG015E104Z
A1C176	283-0479-00			CAP.,FXD,CER DI:0.47UF,+80-20%,25V	20932	501ES25DP474E
A1C177	283-0479-00			CAP.,FXD,CER DI:0.47UF,+80-20%,25V	20932	501ES25DP474E
A1C179	281-0775-00			CAP.,FXD,CER DI:0.1UF,20%,50V	04222	MA205E104MAA
A1C180	283-0421-00			CAP.,FXD,CER DI:0.1UF,+80-20%,50V	04222	DG015E104Z
A1C181	283-0421-00			CAP.,FXD,CER DI:0.1UF,+80-20%,50V	04222	DG015E104Z
A1C184	281-0775-00			CAP.,FXD,CER DI:0.1UF,20%,50V	04222	MA205E104MAA
A1C185	290-0943-00			CAP.,FXD,ELCLT:47UF,+50-10%,25V	55680	ULB1E470TECANA
A1C200	283-0000-00			CAP.,FXD,CER DI:0.001UF,+100-0%,500V (IN COMBO W/R200)	59660	831610Y5U0102P
A1C201	281-0812-00			CAP.,FXD,CER DI:1000PF,10%,100V	04222	MA101C102KAA
A1C202	283-0492-00			CAP.,FXD,CER DI:100PF,20%	20932	501EM50DP10SM
A1C203	283-0421-00	B010100	B019999	CAP.,FXD,CER DI:0.1UF,+80-20%,50V	04222	DG015E104Z
A1C203	281-0862-00	B020000		CAP.,FXD,CER DI:0.001UF,+80-20%,100V	04222	GC70-1E102M
A1C203	283-0811-00	B020115		CAP.,FXD,CER DI:0.01UF,20%,100V	04222	MD011C103MAA
A1C203	-----			(OPTS 01,05,09 OR 1B ONLY)		
A1C205	281-0064-00			CAP.,VAR,PLSTC:0.25-1.5PF,600V	74970	273-0001-101
A1C206	283-0000-00			CAP.,FXD,CER DI:0.001UF,+100-0%,500V	59660	831610Y5U0102P
A1C207	283-0421-00			CAP.,FXD,CER DI:0.1UF,+80-20%,50V	04222	DG015E104Z
A1C217	283-0421-00			CAP.,FXD,CER DI:0.1UF,+80-20%,50V	04222	DG015E104Z
A1C218	290-0943-00			CAP.,FXD,ELCLT:47UF,+50-10%,25V	55680	ULB1E470TECANA
A1C219	283-0024-00			CAP.,FXD,CER DI:0.1UF,+80-20%,50V	72982	8121N083Z5U0104Z
A1C220	283-0024-00			CAP.,FXD,CER DI:0.1UF,+80-20%,50V	72982	8121N083Z5U0104Z
A1C221	290-0943-00			CAP.,FXD,ELCLT:47UF,+50-10%,25V	55680	ULB1E470TECANA
A1C222	283-0010-00			CAP.,FXD,CER DI:0.05UF,+100-20%,50V	56289	1C10Z5U503Z050B
A1C223	281-0770-00			CAP.,FXD,CER DI:1000 PF,20%,100V	04222	MA101C102MAA
A1C225	281-0775-00			CAP.,FXD,CER DI:0.1UF,20%,50V	04222	MA205E104MAA
A1C301	283-0421-00			CAP.,FXD,CER DI:0.1UF,+80-20%,50V	04222	DG015E104Z
A1C302	281-0775-00			CAP.,FXD,CER DI:0.1UF,20%,50V	04222	MA205E104MAA
A1C303	281-0547-00	B010100	B01999	CAP.,FXD,CER DI:2.7PF,10%,500V	04222	7001-COJ-2R7C
A1C306	283-0421-00			CAP.,FXD,CER DI:0.1UF,+80-20%,50V	04222	DG015E104Z
A1C307	290-0943-00			CAP.,FXD,ELCLT:47UF,+50-10%,25V	55680	ULB1E470TECANA
A1C310	283-0421-00			CAP.,FXD,CER DI:0.1UF,+80-20%,50V	04222	DG015E104Z
A1C311	283-0421-00			CAP.,FXD,CER DI:0.1UF,+80-20%,50V	04222	DG015E104Z
A1C312	281-0547-00	B010100	B01999	CAP.,FXD,CER DI:2.7PF,10%,500V	04222	7001-COJ-2R7C
A1C325	290-0943-00			CAP.,FXD,ELCLT:47UF,+50-10%,25V	55680	ULB1E470TECANA

Replaceable Electrical Parts—2445 Service

Component No.	Tektronix Part No.	Serial/Model No. Eff	Dscont	Name & Description	Mfr Code	Mfr Part Number
A1C329	281-0773-00			CAP.,FXD,CER DI:0.01UF,10%,100V	04222	MA201C103KAA
A1C332	281-0773-00			CAP.,FXD,CER DI:0.01UF,10%,100V	04222	MA201C103KAA
A1C336	290-0943-00			CAP.,FXD,ELCTLT:47UF,+50-10%,25V	55680	ULB1E470TECANA
A1C402	281-0762-00			CAP.,FXD,CER DI:27PF,20%,100V	04222	GC101A270M
A1C404	281-0203-00			CAP.,VAR,PLSTC:2-10PF,100V	80031	2807C00210MJ02FO
A1C405	281-0122-00	B020000		CAP.,VAR,CER DI:2.5-9PF,100V	59660	518-000A2.5-9
A1C412	281-0762-00			CAP.,FXD,CER DI:27PF,20%,100V	04222	GC101A270M
A1C415	283-0421-00			CAP.,FXD,CER DI:0.1UF,+80-20%,50V	04222	DG015E104Z
A1C450	283-0421-00	B010100	B010999	CAP.,FXD,CER DI:0.1UF,+80-20%,50V	04222	DG015E104Z
A1C454	283-0421-00	B010100	B010999	CAP.,FXD,CER DI:0.1UF,+80-20%,50V	04222	DG015E104Z
A1C458	283-0421-00			CAP.,FXD,CER DI:0.1UF,+80-20%,50V	04222	DG015E104Z
A1C460	283-0421-00			CAP.,FXD,CER DI:0.1UF,+80-20%,50V	04222	DG015E104Z
A1C464	281-0763-00			CAP.,FXD,CER DI:47PF,10%,100V	04222	GA101A470KAA
A1C478	281-0759-00			CAP.,FXD,CER DI:22PF,10%,100V	96733	R2735
A1C480	281-0775-00			CAP.,FXD,CER DI:0.1UF,20%,50V	04222	MA205E104MAA
A1C487	281-0823-00			CAP.,FXD,CER DI:470PF,10%,50V	12969	CGB471KDN
A1C488	281-0814-00			CAP.,FXD,CER DI:100PF,10%,100V	04222	GC101A101K
A1C500	281-0812-00	B012000		CAP.,FXD,CER DI:1000PF,10%,100V	04222	MA101C102KAA
A1C501	281-0812-00	B012000		CAP.,FXD,CER DI:1000PF,10%,100V	04222	MA101C102KAA
A1C512	290-0246-00			CAP.,FXD,ELCTLT:3.3UF,10%,15V	56289	173D335X9015V
A1C513	281-0775-00	B010100	B019999	CAP.,FXD,CER DI:0.1UF,20%,50V	04222	MA205E104MAA
A1C513	283-0479-00	B020000		CAP.,FXD,CER DI:0.47UF,+80-20%,25V	20932	501ES25DP474E
A1C520	281-0814-00			CAP.,FXD,CER DI:100PF,10%,100V	04222	GC101A101K
A1C521	283-0421-00			CAP.,FXD,CER DI:0.1UF,+80-20%,50V	04222	DG015E104Z
A1C528	283-0421-00			CAP.,FXD,CER DI:0.1UF,+80-20%,50V	04222	DG015E104Z
A1C536	290-0246-00			CAP.,FXD,ELCTLT:3.3UF,10%,15V	56289	173D335X9015V
A1C537	281-0775-00	B010100	B019999	CAP.,FXD,CER DI:0.1UF,20%,50V	04222	MA205E104MAA
A1C537	283-0479-00	B020000		CAP.,FXD,CER DI:0.47UF,+80-20%,25V	20932	501ES25DP474E
A1C544	281-0814-00			CAP.,FXD,CER DI:100PF,10%,100V	04222	GC101A101K
A1C617	281-0773-00			CAP.,FXD,CER DI:0.01UF,10%,100V	04222	MA201C103KAA
A1C625	283-0421-00			CAP.,FXD,CER DI:0.1UF,+80-20%,50V	04222	DG015E104Z
A1C645	281-0773-00			CAP.,FXD,CER DI:0.01UF,10%,100V	04222	MA201C103KAA
A1C650	281-0823-00			CAP.,FXD,CER DI:470PF,10%,50V	12969	CGB471KDN
A1C653	281-0819-00			CAP.,FXD,CER DI:33PF,5%,50V	72982	8035BC0G330
A1C660	281-0786-00	B010100	B019999	CAP.,FXD,CER DI:150PF,10%,100V	04222	MA106A569D
A1C660	281-0851-00	B020000		CAP.,FXD,CER DI:180PF,5%,100VDC	04222	GC10-1-A-181K
A1C669	281-0775-00			CAP.,FXD,CER DI:0.1UF,20%,50V	04222	MA205E104MAA
A1C675	281-0775-00			CAP.,FXD,CER DI:0.1UF,20%,50V	04222	MA205E104MAA
A1C707	281-0808-00			CAP.,FXD,CER DI:7PF,20%,100V	04222	GC10-1A7ROM
A1C708	285-0676-01			CAP.,FXD,PLSTC:0.1UF,3.5%,35V	80009	285-0676-01
A1C709	285-1060-00			CAP.,FXD,PLSTC:10UF,3%,25V	80009	285-1060-00
A1C710	281-0775-00			CAP.,FXD,CER DI:0.1UF,20%,50V	04222	MA205E104MAA
A1C712	283-0479-00			CAP.,FXD,CER DI:0.47UF,+80-20%,25V	20932	501ES25DP474E
A1C722	283-0421-00			CAP.,FXD,CER DI:0.1UF,+80-20%,50V	04222	DG015E104Z
A1C723	290-0943-00			CAP.,FXD,ELCTLT:47UF,+50-10%,25V	55680	ULB1E470TECANA
A1C731	290-0963-00	B010100	B010799	CAP.,FXD,ELCTLT:220UF,+50-10%,25V	70900	SM25VB220Q
A1C731	290-0944-00	B010800		CAP.,FXD,ELCTLT:220UF,+50-10%,10V	55680	ULB1A221TPAANA
A1C733	290-0943-00			CAP.,FXD,ELCTLT:47UF,+50-10%,25V	55680	ULB1E470TECANA
A1C735	281-0823-00			CAP.,FXD,CER DI:470PF,10%,50V	12969	CGB471KDN
A1C738	290-0943-00			CAP.,FXD,ELCTLT:47UF,+50-10%,25V	55680	ULB1E470TECANA
A1C740	290-0943-00			CAP.,FXD,ELCTLT:47UF,+50-10%,25V	55680	ULB1E470TECANA
A1C742	281-0812-00			CAP.,FXD,CER DI:1000PF,10%,100V	04222	MA101C102KAA
A1C803	283-0421-00			CAP.,FXD,CER DI:0.1UF,+80-20%,50V	04222	DG015E104Z
A1C805	281-0823-00			CAP.,FXD,CER DI:470PF,10%,50V	12969	CGB471KDN
A1C806	283-0156-00			CAP.,FXD,CER DI:1000PF,+100-0%,200V	96733	R2670
A1C808	281-0757-00	B010100	B019999	CAP.,FXD,CER DI:10PF,20%,100V	72982	8035-D-COG-100G

Replaceable Electrical Parts—2445 Service

Component No.	Tektronix Part No.	Serial/Model No. Eff	Dscont	Name & Description	Mfr Code	Mfr Part Number
A1C809	281-0819-00			CAP.,FXD,CER DI:33PF,5%,50V	72982	8035BC0G330
A1C810	283-0421-00			CAP.,FXD,CER DI:0.1UF,+80-20%,50V	04222	DG015E104Z
A1C811	283-0421-00			CAP.,FXD,CER DI:0.1UF,+80-20%,50V	04222	DG015E104Z
A1C817	281-0812-00			CAP.,FXD,CER DI:1000PF,10%,100V	04222	MA101C102KAA
A1C819	283-0421-00			CAP.,FXD,CER DI:0.1UF,+80-20%,50V	04222	DG015E104Z
A1C822	283-0421-00			CAP.,FXD,CER DI:0.1UF,+80-20%,50V	04222	DG015E104Z
A1C850	283-0421-00			CAP.,FXD,CER DI:0.1UF,+80-20%,50V	04222	DG015E104Z
A1C851	283-0479-00			CAP.,FXD,CER DI:0.47UF,+80-20%,25V	20932	501ES25DP474E
A1C852	283-0479-00			CAP.,FXD,CER DI:0.47UF,+80-20%,25V	20932	501ES25DP474E
A1C853	283-0479-00			CAP.,FXD,CER DI:0.47UF,+80-20%,25V	20932	501ES25DP474E
A1C854	283-0479-00			CAP.,FXD,CER DI:0.47UF,+80-20%,25V	20932	501ES25DP474E
A1C907	281-0808-00			CAP.,FXD,CER DI:7PF,20%,100V	04222	GC10-1A7ROM
A1C908	285-0752-03			CAP.,FXD,PLSTC:1UF,3%,50V	80009	285-0752-03
A1C912	281-0775-00	B010100	B019999	CAP.,FXD,CER DI:0.1UF,20%,50V	04222	MA205E104MAA
A1C912	283-0421-00	B020000		CAP.,FXD,CER DI:0.1UF,+80-20%,50V	04222	DG015E104Z
A1C933	283-0421-00			CAP.,FXD,CER DI:0.1UF,+80-20%,50V	04222	DG015E104Z
A1C938	283-0421-00			CAP.,FXD,CER DI:0.1UF,+80-20%,50V	04222	DG015E104Z
A1C940	283-0421-00			CAP.,FXD,CER DI:0.1UF,+80-20%,50V	04222	DG015E104Z
A1C943	283-0421-00			CAP.,FXD,CER DI:0.1UF,+80-20%,50V	04222	DG015E104Z
A1C956	281-0773-00			CAP.,FXD,CER DI:0.01UF,10%,100V	04222	MA201C103KAA
A1C957	290-0804-00			CAP.,FXD,ELCTLT:10UF,+50-10%,25V	55680	ULA1E100TEA
A1C958	283-0421-00			CAP.,FXD,CER DI:0.1UF,+80-20%,50V	04222	DG015E104Z
A1C966	281-0783-00			CAP.,FXD,CER DI:0.1UF,20%,100V	96733	ADVISE
A1C967	281-0783-00	B020000		CAP.,FXD,CER DI:0.1UF,20%,100V	96733	ADVISE
A1C972	281-0756-00			CAP.,FXD,CER DI:2.2PF,0.5%,200V	12969	CGB2R2DFN
A1C973	283-0421-00			CAP.,FXD,CER DI:0.1UF,+80-20%,50V	04222	DG015E104Z
A1C975	281-0775-00			CAP.,FXD,CER DI:0.1UF,20%,50V	04222	MA205E104MAA
A1C980	281-0775-00			CAP.,FXD,CER DI:0.1UF,20%,50V	04222	MA205E104MAA
A1C988	283-0421-00			CAP.,FXD,CER DI:0.1UF,+80-20%,50V	04222	DG015E104Z
A1C990	283-0421-00			CAP.,FXD,CER DI:0.1UF,+80-20%,50V	04222	DG015E104Z
A1C995	281-0810-00			CAP.,FXD,CER DI:5.6PF,0.5%,100V	04222	GC10-1A5R6D
A1CR100	152-0323-00			SEMICONV DEVICE:SILICON,35V,0.1A	80009	152-0323-00
A1CR100	-----			(IN COMBO W/CR200)		
A1CR101	152-0322-00	B010100	B01319	SEMICONV DEVICE:SILICON,15V,HOT CARRIER	50434	5082-2672
A1CR101	-----			(IN COMBO W/CR201)		
A1CR101	152-0323-01	B013200		SEMICONV DEVICE:SILICON,35V,0.1A	03508	DE101
A1CR101	-----			(IN COMBO W/CR201)		
A1CR107	152-0066-00			SEMICONV DEVICE:SILICON,400V,750MA	14433	LG4016
A1CR130	152-0141-02			SEMICONV DEVICE:SILICON,30V,150MA	01295	1N4152R
A1CR131	152-0141-02			SEMICONV DEVICE:SILICON,30V,150MA	01295	1N4152R
A1CR140	152-0141-02			SEMICONV DEVICE:SILICON,30V,150MA	01295	1N4152R
A1CR141	152-0141-02			SEMICONV DEVICE:SILICON,30V,150MA	01295	1N4152R
A1CR142	152-0141-02			SEMICONV DEVICE:SILICON,30V,150MA	01295	1N4152R
A1CR143	152-0141-02			SEMICONV DEVICE:SILICON,30V,150MA	01295	1N4152R
A1CR144	152-0141-02			SEMICONV DEVICE:SILICON,30V,150MA	01295	1N4152R
A1CR145	152-0141-02			SEMICONV DEVICE:SILICON,30V,150MA	01295	1N4152R
A1CR146	152-0141-02			SEMICONV DEVICE:SILICON,30V,150MA	01295	1N4152R
A1CR147	152-0141-02			SEMICONV DEVICE:SILICON,30V,150MA	01295	1N4152R
A1CR148	152-0141-02			SEMICONV DEVICE:SILICON,30V,150MA	01295	1N4152R
A1CR149	152-0141-02			SEMICONV DEVICE:SILICON,30V,150MA	01295	1N4152R
A1CR150	152-0141-02			SEMICONV DEVICE:SILICON,30V,150MA	01295	1N4152R
A1CR151	152-0141-02			SEMICONV DEVICE:SILICON,30V,150MA	01295	1N4152R
A1CR152	152-0141-02			SEMICONV DEVICE:SILICON,30V,150MA	01295	1N4152R
A1CR153	152-0141-02			SEMICONV DEVICE:SILICON,30V,150MA	01295	1N4152R

Replaceable Electrical Parts—2445 Service

Component No.	Tektronix Part No.	Serial/Model No. Eff	Dscont	Name & Description	Mfr Code	Mfr Part Number
A1CR154	152-0141-02			SEMICONV DEVICE:SILICON,30V,150MA	01295	1N4152R
A1CR155	152-0141-02			SEMICONV DEVICE:SILICON,30V,150MA	01295	1N4152R
A1CR160	152-0141-02			SEMICONV DEVICE:SILICON,30V,150MA	01295	1N4152R
A1CR161	152-0141-02			SEMICONV DEVICE:SILICON,30V,150MA	01295	1N4152R
A1CR162	152-0141-02			SEMICONV DEVICE:SILICON,30V,150MA	01295	1N4152R
A1CR163	152-0141-02			SEMICONV DEVICE:SILICON,30V,150MA	01295	1N4152R
A1CR200	152-0323-01			SEMICONV DEVICE:SILICON,35V,0.1A	03508	DE101
A1CR200	-----			(IN COMBO W/CR100)		
A1CR201	152-0322-00	B010100	B013199	SEMICONV DEVICE:SILICON,15V,HOT CARRIER	50434	5082-2672
A1CR201	-----			(IN COMBO W/CR101)		
A1CR201	152-0323-01	B013200		SEMICONV DEVICE:SILICON,35V,0.1A	03508	DE101
A1CR201	-----			(IN COMBO W/CR101)		
A1CR355	152-0141-02			SEMICONV DEVICE:SILICON,30V,150MA	01295	1N4152R
A1CR356	152-0141-02			SEMICONV DEVICE:SILICON,30V,150MA	01295	1N4152R
A1CR358	152-0141-02			SEMICONV DEVICE:SILICON,30V,150MA	01295	1N4152R
A1CR359	152-0141-02			SEMICONV DEVICE:SILICON,30V,150MA	01295	1N4152R
A1CR460	152-0141-02			SEMICONV DEVICE:SILICON,30V,150MA	01295	1N4152R
A1CR461	152-0141-02			SEMICONV DEVICE:SILICON,30V,150MA	01295	1N4152R
A1CR476	152-0141-02			SEMICONV DEVICE:SILICON,30V,150MA	01295	1N4152R
A1CR484	152-0141-02			SEMICONV DEVICE:SILICON,30V,150MA	01295	1N4152R
A1CR485	152-0141-02			SEMICONV DEVICE:SILICON,30V,150MA	01295	1N4152R
A1CR495	152-0141-02			SEMICONV DEVICE:SILICON,30V,150MA	01295	1N4152R
A1CR503	152-0141-02	B020000		SEMICONV DEVICE:SILICON,30V,150MA	01295	1N4152R
A1CR600	152-0141-02			SEMICONV DEVICE:SILICON,30V,150MA	01295	1N4152R
A1CR601	152-0141-02	B011400		SEMICONV DEVICE:SILICON,30V,150MA	01295	1N4152R
A1CR616	152-0141-02			SEMICONV DEVICE:SILICON,30V,150MA	01295	1N4152R
A1CR619	152-0141-02	B011400		SEMICONV DEVICE:SILICON,30V,150MA	01295	1N4152R
A1CR620	152-0141-02	B011400		SEMICONV DEVICE:SILICON,30V,150MA	01295	1N4152R
A1CR621	152-0141-02	B011400		SEMICONV DEVICE:SILICON,30V,150MA	01295	1N4152R
A1CR652	152-0141-02			SEMICONV DEVICE:SILICON,30V,150MA	01295	1N4152R
A1CR653	152-0141-02			SEMICONV DEVICE:SILICON,30V,150MA	01295	1N4152R
A1CR707	152-0141-02			SEMICONV DEVICE:SILICON,30V,150MA	01295	1N4152R
A1CR741	152-0141-02			SEMICONV DEVICE:SILICON,30V,150MA	01295	1N4152R
A1CR746	152-0141-02			SEMICONV DEVICE:SILICON,30V,150MA	01295	1N4152R
A1CR747	152-0141-02			SEMICONV DEVICE:SILICON,30V,150MA	01295	1N4152R
A1CR807	152-0574-00			SEMICONV DEVICE:SILICON,120V,0.15A	14433	WG1308
A1CR811	152-0141-02			SEMICONV DEVICE:SILICON,30V,150MA	01295	1N4152R
A1CR871	152-0141-02			SEMICONV DEVICE:SILICON,30V,150MA	01295	1N4152R
A1CR950	152-0141-02			SEMICONV DEVICE:SILICON,30V,150MA	01295	1N4152R
A1CR951	152-0141-02			SEMICONV DEVICE:SILICON,30V,150MA	01295	1N4152R
A1CR956	152-0141-02			SEMICONV DEVICE:SILICON,30V,150MA	01295	1N4152R
A1CR966	152-0574-00			SEMICONV DEVICE:SILICON,120V,0.15A	14433	WG1308
A1CR972	152-0574-00			SEMICONV DEVICE:SILICON,120V,0.15A	14433	WG1308
A1CR987	152-0574-00			SEMICONV DEVICE:SILICON,120V,0.15A	14433	WG1308
A1DL100	119-1490-00			DELAY LINE,ELEK:73NS,150 OHM	80009	119-1490-00
A1J100	131-0608-00	B010100	B019999	TERMINAL,PIN:0.365 L X 0.025 PH BRZ GOLD	22526	47357
A1J110	136-0727-00			SKT,PL-IN ELEK:MICROCKT,8 CONTACT	09922	DILB8P-108
A1J118	136-0727-00			SKT,PL-IN ELEK:MICROCKT,8 CONTACT	09922	DILB8P-108
A1J119	136-0728-00			SKT,PL-IN ELEK:MICROCKT,14 CONTACT	09922	DILB14P-108
A1L101	108-0538-00			COIL,RF:2.7UH	76493	JWM#B7059
A1L107	108-0538-00			COIL,RF:2.7UH	76493	JWM#B7059

Replaceable Electrical Parts—2445 Service

Component No.	Tektronix Part No.	Serial/Model No.		Name & Description	Mfr Code	Mfr Part Number
		Eff	Dscont			
A1L113	108-0538-00			COIL,RF:2.7UH	76493	JWM#B7059
A1L115	108-0317-00			COIL,RF:FIXED,15UH	32159	71501M
A1L219	108-0538-00			COIL,RF:2.7UH	76493	JWM#B7059
A1L307	108-0538-00			COIL,RF:2.7UH	76493	JWM#B7059
A1L325	108-0538-00			COIL,RF:2.7UH	76493	JWM#B7059
A1L336	108-0538-00			COIL,RF:2.7UH	76493	JWM#B7059
A1L521	108-0538-00			COIL,RF:2.7UH	76493	JWM#B7059
A1L605	108-0735-00			COIL,RF:FIXED,560NH	80009	108-0735-00
A1L606	108-0683-00			COIL,RF:FIXED,900NH	80009	108-0683-00
A1L607	108-0683-00			COIL,RF:FIXED,900NH	80009	108-0683-00
A1L608	108-0735-00			COIL,RF:FIXED,560NH	80009	108-0735-00
A1L609	108-0509-00			COIL,RF:2.45UH	80009	108-0509-00
A1L610	108-0509-00			COIL,RF:2.45UH	80009	108-0509-00
A1L611	108-0317-00			COIL,RF:FIXED,15UH	32159	71501M
A1L612	108-0317-00			COIL,RF:FIXED,15UH	32159	71501M
A1L619	108-0735-00	B010100	B019999	COIL,RF:FIXED,560NH	80009	108-0735-00
A1L619	114-0353-00	B020000		COIL,RF:VARIABLE,0.6 TO 1.0UH	80009	114-0353-00
A1L628	108-0327-00	B020000		COIL,RF:XD,TERMINATION COMP	80009	108-0327-00
A1L633	108-0327-00	B020000		COIL,RF:XD,TERMINATION COMP	80009	108-0327-00
A1L644	108-0736-00	B010100	B019999	COIL,RF:810NH	80009	108-0736-00
A1L644	114-0353-00	B020000		COIL,RF:VARIABLE,0.6 TO 1.0UH	80009	114-0353-00
A1L733	108-0538-00			COIL,RF:2.7UH	76493	JWM#B7059
A1L738	108-0317-00			COIL,RF:FIXED,15UH	32159	71501M
A1L740	108-0317-00			COIL,RF:FIXED,15UH	32159	71501M
A1L743	108-0538-00			COIL,RF:2.7UH	76493	JWM#B7059
A1L938	108-0538-00			COIL,RF:2.7UH	76493	JWM#B7059
A1L973	108-0538-00			COIL,RF:2.7UH	76493	JWM#B7059
A1LR101	108-0325-00			COIL,RF:0.5UH	80009	108-0325-00
A1LR107	108-0325-00			COIL,RF:0.5UH	80009	108-0325-00
A1LR180	108-0999-00			COIL,RF:FIXED,105NH ON FORM	80009	108-0999-00
A1LR201	108-0325-00			COIL,RF:0.5UH	80009	108-0325-00
A1LR218	108-0330-00			COIL,RF:0.4UH	80009	108-0330-00
A1LR280	108-0999-00			COIL,RF:FIXED,105NH ON FORM	80009	108-0999-00
A1Q130	151-0622-00			TRANSISTOR:SILICON,PNP		
A1Q131	151-0622-00			TRANSISTOR:SILICON,PNP		
A1Q154	151-0188-00			TRANSISTOR:SILICON,PNP	04713	SPS6868
A1Q155	151-0188-00			TRANSISTOR:SILICON,PNP	04713	SPS6868
A1Q190	151-0190-00			TRANSISTOR:SILICON,NPN	07263	S032677
A1Q460A,B	153-0547-00			SEMICONDC DVC SE:SILICON,NPN,MATCHED	80009	153-0547-00
A1Q550	151-0190-00			TRANSISTOR:SILICON,NPN	07263	S032677
A1Q600	151-0190-00			TRANSISTOR:SILICON,NPN	07263	S032677
A1Q623	151-0190-00			TRANSISTOR:SILICON,NPN	07263	S032677
A1Q624	151-1042-01	B010100	B019999	SEMICONDC DVC SE:FET,SI,TO-92	17856	J2595
A1Q624	151-1025-00	B020000		TRANSISTOR:SILICON,JFE,N-CHANNEL	01295	SFB8129
A1Q645	151-0188-00			TRANSISTOR:SILICON,PNP	04713	SPS6868
A1Q700	151-0190-00			TRANSISTOR:SILICON,NPN	07263	S032677
A1Q709	151-0736-00			TRANSISTOR:SILICON,NPN	04713	SPS8317
A1Q741	151-0188-00			TRANSISTOR:SILICON,PNP	04713	SPS6868
A1R100	315-0474-00			RES.,FXD,CMPSN:470K OHM,5%,0.25W	01121	CB4745
A1R100	-----			(IN COMBO W/C100)		
A1R101	315-0272-00			RES.,FXD,CMPSN:2.7K OHM,5%,0.25W	01121	CB2725
A1R102	315-0272-00			RES.,FXD,CMPSN:2.7K OHM,5%,0.25W	01121	CB2725
A1R114	321-0130-00			RES.,FXD,FILM:221 OHM,1%,0.125W	91637	MFF1816G221R0F

Replaceable Electrical Parts—2445 Service

Component No.	Tektronix Part No.	Serial/Model No. Eff	Dscont	Name & Description	Mfr Code	Mfr Part Number
A1R115	321-0146-00			RES.,FXD,FILM:324 OHM,1%,0.125W	91637	MFF1816G324R0F
A1R117	321-0285-00			RES.,FXD,FILM:9.09K OHM,1%,0.125W	91637	MFF1816G90900F
A1R118	321-0210-00			RES.,FXD,FILM:1.5K OHM,1%,0.125W	91637	MFF1816G15000F
A1R119	321-0354-00			RES.,FXD,FILM:47.5K OHM,1%,0.125W	91637	CMF55116G47501F
A1R120	315-0100-00			RES.,FXD,CMPSN:10 OHM,5%,0.25W	01121	CB1005
A1R121	315-0121-00	B010100	B019999	RES.,FXD,CMPSN:120 OHM,5%,0.25W	01121	CB1215
A1R123	315-0622-00			RES.,FXD,CMPSN:6.2K OHM,5%,0.25W	01121	CB6225
A1R125	301-0361-00			RES.,FXD,CMPSN:360 OHM,5%,0.5W	01121	EB3615
A1R129	315-0101-00			RES.,FXD,CMPSN:100 OHM<5%,0.25W	01121	CB1015
A1R130	315-0561-00			RES.,FXD,CMPSN:560 OHM,5%,0.25W	01121	CB5615
A1R131	315-0561-00			RES.,FXD,CMPSN:560 OHM,5%,0.25W	01121	CB5615
A1R133	315-0122-00			RES.,FXD,CMPSN:1.2K OHM,5%,0.25W	01121	CB1225
A1R135	315-0102-00			RES.,FXD,CMPSN:1K OHM,5%,0.25W	01121	CB1025
A1R136	315-0622-00			RES.,FXD,CMPSN:6.2K OHM,5%,0.25W	01121	CB6225
A1R140	315-0471-00			RES.,FXD,CMPSN:470 OHM,5%,0.25W	01121	CB4715
A1R141	315-0471-00			RES.,FXD,CMPSN:470 OHM,5%,0.25W	01121	CB4715
A1R142	315-0391-00			RES.,FXD,CMPSN:390 OHM,5%,0.25W	01121	CB3915
A1R143	315-0391-00			RES.,FXD,CMPSN:390 OHM,5%,0.25W	01121	CB3915
A1R144	307-0108-00			RES.,FXD,CMPSN:6.8 OHM,5%,0.25W	01121	CB68G5
A1R149	315-0103-00			RES.,FXD,CMPSN:10K OHM,5%,0.25W	01121	CB1035
A1R152	315-0562-00			RES.,FXD,CMPSN:5.6K OHM,5%,0.25W	01121	CB5625
A1R153	315-0752-00			RES.,FXD,CMPSN:7.5K OHM,5%,0.25W	01121	CB7525
A1R154	321-0210-00			RES.,FXD,FILM:1.5K OHM,1%,0.125W	91637	MFF1816G15000F
A1R155	321-0210-00	B010100	B019999	RES.,FXD,FILM:1.5K OHM,1%,0.125W	91637	MFF1816G15000F
A1R155	321-0206-00	B020000		RES.,FXD,FILM:1.37K OHM,1%,0.125W	91637	MFF1816G13700F
A1R156	321-0255-00			RES.,FXD,FILM:4.42K OHM,1%,0.125W	91637	MFF1816G44200F
A1R159	321-0242-00			RES.,FXD,FILM:3.24K OHM,1%,0.125W	91637	MFF1816G32400F
A1R161	321-0289-00			RES.,FXD,FILM:10K OHM,1%,0.125W	91637	MFF1816G10001F
A1R162	321-0289-00			RES.,FXD,FILM:10K OHM,1%,0.125W	91637	MFF1816G10001F
A1R163	321-0242-00			RES.,FXD,FILM:3.24K OHM,1%,0.125W	91637	MFF1816G32400F
A1R165	315-0822-00			RES.,FXD,CMPSN:8.2K OHM,5%,0.25W	01121	CB8225
A1R190	315-0103-00			RES.,FXD,CMPSN:10K OHM,5%,0.25W	01121	CB1035
A1R191	315-0103-00			RES.,FXD,CMPSN:10K OHM,5%,0.25W	01121	CB1035
A1R192	315-0103-00			RES.,FXD,CMPSN:10K OHM,5%,0.25W	01121	CB1035
A1R193	315-0102-00			RES.,FXD,CMPSN:1K OHM,5%,0.25W	01121	CB1025
A1R194	317-0105-00	B010100	B019999	RES.,FXD,CMPSN:1M OHM,5%,0.125W	01121	BB1055
A1R194	315-0103-00	B020000		RES.,FXD,CMPSN:10K OHM,5%,0.25W	01121	CB1035
A1R195	315-0301-00			RES.,FXD,CMPSN:300 OHM,5%,0.25W	01121	CB3015
A1R196	315-0752-00			RES.,FXD,CMPSN:7.5K OHM,5%,0.25W	01121	CB7525
A1R197	315-0562-00			RES.,FXD,CMPSN:5.6K OHM,5%,0.25W	01121	CB5625
A1R198	321-1700-04			RES.,FXD,FILM:10.44K OHM,0.1%,0.125W	91637	MFF1816D10441B
A1R199	321-1700-04			RES.,FXD,FILM:10.44K OHM,0.1%,0.125W	91637	MFF1816D10441B
A1R200	315-0474-00			RES.,FXD,CMPSN:470K OHM,5%,0.25W	01121	CB4745
A1R200	-----			(IN COMBO W/C200)		
A1R201	315-0272-00			RES.,FXD,CMPSN:2.7K OHM,5%,0.25W	01121	CB2725
A1R202	315-0272-00			RES.,FXD,CMPSN:2.7K OHM,5%,0.25W	01121	CB2725
A1R216	315-0121-00	B010100	B019999	RES.,FXD,CMPSN:120 OHM,5%,0.25W	01121	CB1215
A1R217	321-0268-00			RES.,FXD,FILM:6.04K OHM,1%,0.125W	91637	MFF1816G60400F
A1R218	321-0210-00			RES.,FXD,FILM:1.5K OHM,1%,0.125W	91637	MFF1816G15000F
A1R219	321-0354-00			RES.,FXD,FILM:47.5K OHM,1%,0.125W	91637	CMF55116G47501F
A1R220	315-0100-00			RES.,FXD,CMPSN:10 OHM,5%,0.25W	01121	CB1005
A1R223	315-0622-00			RES.,FXD,CMPSN:6.2K OHM,5%,0.25W	01121	CB6225
A1R225	301-0361-00			RES.,FXD,CMPSN:360 OHM,5%,0.5W	01121	EB3615
A1R230	315-0222-00			RES.,FXD,CMPSN:2.2K OHM,5%,0.25W	01121	CB2225
A1R231	315-0222-00			RES.,FXD,CMPSN:2.2K OHM,5%,0.25W	01121	CB2225
A1R232	315-0222-00			RES.,FXD,CMPSN:2.2K OHM,5%,0.25W	01121	CB2225
A1R301	315-0240-00			RES.,FXD,CMPSN:24 OHM,5%,0.25W	01121	CB2405

Replaceable Electrical Parts—2445 Service

Component No.	Tektronix Part No.	Serial/Model No.		Name & Description	Mfr Code	Mfr Part Number
		Eff	Dscont			
A1L113	108-0538-00			COIL,RF:2.7UH	76493	JWM#B7059
A1L115	108-0317-00			COIL,RF:FIXED,15UH	32159	71501M
A1L219	108-0538-00			COIL,RF:2.7UH	76493	JWM#B7059
A1L307	108-0538-00			COIL,RF:2.7UH	76493	JWM#B7059
A1L325	108-0538-00			COIL,RF:2.7UH	76493	JWM#B7059
A1L336	108-0538-00			COIL,RF:2.7UH	76493	JWM#B7059
A1L521	108-0538-00			COIL,RF:2.7UH	76493	JWM#B7059
A1L605	108-0735-00			COIL,RF:FIXED,560NH	80009	108-0735-00
A1L606	108-0683-00			COIL,RF:FIXED,900NH	80009	108-0683-00
A1L607	108-0683-00			COIL,RF:FIXED,900NH	80009	108-0683-00
A1L608	108-0735-00			COIL,RF:FIXED,560NH	80009	108-0735-00
A1L609	108-0509-00			COIL,RF:2.45UH	80009	108-0509-00
A1L610	108-0509-00			COIL,RF:2.45UH	80009	108-0509-00
A1L611	108-0317-00			COIL,RF:FIXED,15UH	32159	71501M
A1L612	108-0317-00			COIL,RF:FIXED,15UH	32159	71501M
A1L619	108-0735-00	B010100	B019999	COIL,RF:FIXED,560NH	80009	108-0735-00
A1L619	114-0353-00	B020000		COIL,RF:VARIABLE,0.6 TO 1.0UH	80009	114-0353-00
A1L628	108-0327-00	B020000		COIL,RF:XD,TERMINATION COMP	80009	108-0327-00
A1L633	108-0327-00	B020000		COIL,RF:XD,TERMINATION COMP	80009	108-0327-00
A1L644	108-0736-00	B010100	B019999	COIL,RF:810NH	80009	108-0736-00
A1L644	114-0353-00	B020000		COIL,RF:VARIABLE,0.6 TO 1.0UH	80009	114-0353-00
A1L733	108-0538-00			COIL,RF:2.7UH	76493	JWM#B7059
A1L738	108-0317-00			COIL,RF:FIXED,15UH	32159	71501M
A1L740	108-0317-00			COIL,RF:FIXED,15UH	32159	71501M
A1L743	108-0538-00			COIL,RF:2.7UH	76493	JWM#B7059
A1L938	108-0538-00			COIL,RF:2.7UH	76493	JWM#B7059
A1L973	108-0538-00			COIL,RF:2.7UH	76493	JWM#B7059
A1LR101	108-0325-00			COIL,RF:0.5UH	80009	108-0325-00
A1LR107	108-0325-00			COIL,RF:0.5UH	80009	108-0325-00
A1LR180	108-0999-00			COIL,RF:FIXED,105NH ON FORM	80009	108-0999-00
A1LR201	108-0325-00			COIL,RF:0.5UH	80009	108-0325-00
A1LR218	108-0330-00			COIL,RF:0.4UH	80009	108-0330-00
A1LR280	108-0999-00			COIL,RF:FIXED,105NH ON FORM	80009	108-0999-00
A1Q130	151-0622-00			TRANSISTOR:SILICON,PNP		
A1Q131	151-0622-00			TRANSISTOR:SILICON,PNP		
A1Q154	151-0188-00			TRANSISTOR:SILICON,PNP	04713	SPS6868
A1Q155	151-0188-00			TRANSISTOR:SILICON,PNP	04713	SPS6868
A1Q190	151-0190-00			TRANSISTOR:SILICON,NPN	07263	S032677
A1Q460A,B	153-0547-00			SEMICON DVC SE:SILICON,NPN,MATCHED	80009	153-0547-00
A1Q550	151-0190-00			TRANSISTOR:SILICON,NPN	07263	S032677
A1Q600	151-0190-00			TRANSISTOR:SILICON,NPN	07263	S032677
A1Q623	151-0190-00			TRANSISTOR:SILICON,NPN	07263	S032677
A1Q624	151-1042-01	B010100	B019999	SEMICON DVC SE:FET,SI,TO-92	17856	J2595
A1Q624	151-1025-00	B020000		TRANSISTOR:SILICON,JFE,N-CHANNEL	01295	SFB8129
A1Q645	151-0188-00			TRANSISTOR:SILICON,PNP	04713	SPS6868
A1Q700	151-0190-00			TRANSISTOR:SILICON,NPN	07263	S032677
A1Q709	151-0736-00			TRANSISTOR:SILICON,NPN	04713	SPS8317
A1Q741	151-0188-00			TRANSISTOR:SILICON,PNP	04713	SPS6868
A1R100	315-0474-00			RES.,FXD,CMPSN:470K OHM,5%,0.25W	01121	CB4745
A1R100	-----			(IN COMBO W/C100)		
A1R101	315-0272-00			RES.,FXD,CMPSN:2.7K OHM,5%,0.25W	01121	CB2725
A1R102	315-0272-00			RES.,FXD,CMPSN:2.7K OHM,5%,0.25W	01121	CB2725
A1R114	321-0130-00			RES.,FXD,FILM:221 OHM,1%,0.125W	91637	MFF1816G221R0F

Replaceable Electrical Parts—2445 Service

Component No.	Tektronix Part No.	Serial/Model No. Eff	Dscont	Name & Description	Mfr Code	Mfr Part Number
A1R115	321-0146-00			RES.,FXD,FILM:324 OHM,1%,0.125W	91637	MFF1816G324R0F
A1R117	321-0285-00			RES.,FXD,FILM:9.09K OHM,1%,0.125W	91637	MFF1816G90900F
A1R118	321-0210-00			RES.,FXD,FILM:1.5K OHM,1%,0.125W	91637	MFF1816G15000F
A1R119	321-0354-00			RES.,FXD,FILM:47.5K OHM,1%,0.125W	91637	CMF55116G47501F
A1R120	315-0100-00			RES.,FXD,CMPSN:10 OHM,5%,0.25W	01121	CB1005
A1R121	315-0121-00	B010100	B019999	RES.,FXD,CMPSN:120 OHM,5%,0.25W	01121	CB1215
A1R123	315-0622-00			RES.,FXD,CMPSN:6.2K OHM,5%,0.25W	01121	CB6225
A1R125	301-0361-00			RES.,FXD,CMPSN:360 OHM,5%,0.5W	01121	EB3615
A1R129	315-0101-00			RES.,FXD,CMPSN:100 OHM<5%,0.25W	01121	CB1015
A1R130	315-0561-00			RES.,FXD,CMPSN:560 OHM,5%,0.25W	01121	CB5615
A1R131	315-0561-00			RES.,FXD,CMPSN:560 OHM,5%,0.25W	01121	CB5615
A1R133	315-0122-00			RES.,FXD,CMPSN:1.2K OHM,5%,0.25W	01121	CB1225
A1R135	315-0102-00			RES.,FXD,CMPSN:1K OHM,5%,0.25W	01121	CB1025
A1R136	315-0622-00			RES.,FXD,CMPSN:6.2K OHM,5%,0.25W	01121	CB6225
A1R140	315-0471-00			RES.,FXD,CMPSN:470 OHM,5%,0.25W	01121	CB4715
A1R141	315-0471-00			RES.,FXD,CMPSN:470 OHM,5%,0.25W	01121	CB4715
A1R142	315-0391-00			RES.,FXD,CMPSN:390 OHM,5%,0.25W	01121	CB3915
A1R143	315-0391-00			RES.,FXD,CMPSN:390 OHM,5%,0.25W	01121	CB3915
A1R144	307-0108-00			RES.,FXD,CMPSN:6.8 OHM,5%,0.25W	01121	CB68G5
A1R149	315-0103-00			RES.,FXD,CMPSN:10K OHM,5%,0.25W	01121	CB1035
A1R152	315-0562-00			RES.,FXD,CMPSN:5.6K OHM,5%,0.25W	01121	CB5625
A1R153	315-0752-00			RES.,FXD,CMPSN:7.5K OHM,5%,0.25W	01121	CB7525
A1R154	321-0210-00			RES.,FXD,FILM:1.5K OHM,1%,0.125W	91637	MFF1816G15000F
A1R155	321-0210-00	B010100	B019999	RES.,FXD,FILM:1.5K OHM,1%,0.125W	91637	MFF1816G15000F
A1R155	321-0206-00	B020000		RES.,FXD,FILM:1.37K OHM,1%,0.125W	91637	MFF1816G13700F
A1R156	321-0255-00			RES.,FXD,FILM:4.42K OHM,1%,0.125W	91637	MFF1816G44200F
A1R159	321-0242-00			RES.,FXD,FILM:3.24K OHM,1%,0.125W	91637	MFF1816G32400F
A1R161	321-0289-00			RES.,FXD,FILM:10K OHM,1%,0.125W	91637	MFF1816G10001F
A1R162	321-0289-00			RES.,FXD,FILM:10K OHM,1%,0.125W	91637	MFF1816G10001F
A1R163	321-0242-00			RES.,FXD,FILM:3.24K OHM,1%,0.125W	91637	MFF1816G32400F
A1R165	315-0822-00			RES.,FXD,CMPSN:8.2K OHM,5%,0.25W	01121	CB8225
A1R190	315-0103-00			RES.,FXD,CMPSN:10K OHM,5%,0.25W	01121	CB1035
A1R191	315-0103-00			RES.,FXD,CMPSN:10K OHM,5%,0.25W	01121	CB1035
A1R192	315-0103-00			RES.,FXD,CMPSN:10K OHM,5%,0.25W	01121	CB1035
A1R193	315-0102-00			RES.,FXD,CMPSN:1K OHM,5%,0.25W	01121	CB1025
A1R194	317-0105-00	B010100	B019999	RES.,FXD,CMPSN:1M OHM,5%,0.125W	01121	BB1055
A1R194	315-0103-00	B020000		RES.,FXD,CMPSN:10K OHM,5%,0.25W	01121	CB1035
A1R195	315-0301-00			RES.,FXD,CMPSN:300 OHM,5%,0.25W	01121	CB3015
A1R196	315-0752-00			RES.,FXD,CMPSN:7.5K OHM,5%,0.25W	01121	CB7525
A1R197	315-0562-00			RES.,FXD,CMPSN:5.6K OHM,5%,0.25W	01121	CB5625
A1R198	321-1700-04			RES.,FXD,FILM:10.44K OHM,0.1%,0.125W	91637	MFF1816D10441B
A1R199	321-1700-04			RES.,FXD,FILM:10.44K OHM,0.1%,0.125W	91637	MFF1816D10441B
A1R200	315-0474-00			RES.,FXD,CMPSN:470K OHM,5%,0.25W	01121	CB4745
A1R200	-----			(IN COMBO W/C200)		
A1R201	315-0272-00			RES.,FXD,CMPSN:2.7K OHM,5%,0.25W	01121	CB2725
A1R202	315-0272-00			RES.,FXD,CMPSN:2.7K OHM,5%,0.25W	01121	CB2725
A1R216	315-0121-00	B010100	B019999	RES.,FXD,CMPSN:120 OHM,5%,0.25W	01121	CB1215
A1R217	321-0268-00			RES.,FXD,FILM:6.04K OHM,1%,0.125W	91637	MFF1816G60400F
A1R218	321-0210-00			RES.,FXD,FILM:1.5K OHM,1%,0.125W	91637	MFF1816G15000F
A1R219	321-0354-00			RES.,FXD,FILM:47.5K OHM,1%,0.125W	91637	CMF55116G47501F
A1R220	315-0100-00			RES.,FXD,CMPSN:10 OHM,5%,0.25W	01121	CB1005
A1R223	315-0622-00			RES.,FXD,CMPSN:6.2K OHM,5%,0.25W	01121	CB6225
A1R225	301-0361-00			RES.,FXD,CMPSN:360 OHM,5%,0.5W	01121	EB3615
A1R230	315-0222-00			RES.,FXD,CMPSN:2.2K OHM,5%,0.25W	01121	CB2225
A1R231	315-0222-00			RES.,FXD,CMPSN:2.2K OHM,5%,0.25W	01121	CB2225
A1R232	315-0222-00			RES.,FXD,CMPSN:2.2K OHM,5%,0.25W	01121	CB2225
A1R301	315-0240-00			RES.,FXD,CMPSN:24 OHM,5%,0.25W	01121	CB2405

Replaceable Electrical Parts—2445 Service

Component No.	Tektronix	Serial/Model No.		Name & Description	Mfr Code	Mfr Part Number
	Part No.	Eff	Dscont			
A1R302	315-0240-00			RES.,FXD,CMPSN:24 OHM,5%,0.25W	01121	CB2405
A1R304	315-0101-00			RES.,FXD,CMPSN:100 OHM<5%,0.25W	01121	CB1015
A1R311	315-0101-00			RES.,FXD,CMPSN:100 OHM<5%,0.25W	01121	CB1015
A1R329	315-0101-00			RES.,FXD,CMPSN:100 OHM<5%,0.25W	01121	CB1015
A1R332	315-0101-00			RES.,FXD,CMPSN:100 OHM<5%,0.25W	01121	CB1015
A1R334	315-0392-00			RES.,FXD,CMPSN:3.9K OHM,5%,0.25W	01121	CB3925
A1R353	321-0265-00			RES.,FXD,FILM:5.62K OHM,1%,0.125W	91637	MFF1816G56200F
A1R355	315-0103-00			RES.,FXD,CMPSN:10K OHM,5%,0.25W	01121	CB1035
A1R357	315-0104-00			RES.,FXD,CMPSN:100K OHM,5%,0.25W	01121	CB1045
A1R358	315-0104-00			RES.,FXD,CMPSN:100K OHM,5%,0.25W	01121	CB1045
A1R359	315-0104-00			RES.,FXD,CMPSN:100K OHM,5%,0.25W	01121	CB1045
A1R360	321-0293-00			RES.,FXD,FILM:11K OHM,1%,0.125W	91637	MFF1816G11001F
A1R361	315-0123-00			RES.,FXD,CMPSN:12K OHM,5%,0.25W	01121	CB1235
A1R362	315-0104-00			RES.,FXD,CMPSN:100K OHM,5%,0.25W	01121	CB1045
A1R363	315-0332-00			RES.,FXD,CMPSN:3.3K OHM,5%,0.25W	01121	CB3325
A1R401	321-0202-00			RES.,FXD,FILM:1.24K OHM,1%,0.125W	91637	MFF1816G12400F
A1R402	315-0750-00			RES.,FXD,CMPSN:75 OHM,5%,0.25W	01121	CB7505
A1R403	311-1137-00	B010100	B019999	RES.,VAR,NONWIR:5K OHM,20%,0.50W	73138	72PX-67-0-502M
A1R403	311-2099-00	B020000		RES.,VAR,NONWIR:TRMR,500 OHM,10%,0.5W	73138	72PXR500-266A
A1R405	315-0470-00	B020000		RES.,FXD,CMPSN:47 OHM,5%,0.25W	01121	CB4705
A1R412	315-0750-00			RES.,FXD,CMPSN:75 OHM,5%,0.25W	01121	CB7505
A1R416	315-0432-00			RES.,FXD,CMPSN:4.3K OHM,5%,0.25W	01121	CB4325
A1R430	315-0201-00			RES.,FXD,CMPSN:200 OHM,5%,0.25W	01121	CB2015
A1R431	315-0470-00	B020000		RES.,FXD,CMPSN:47 OHM,5%,0.25W	01121	CB4705
A1R440	321-0666-00			RES.,FXD,FILM:3.04K OHM,0.5%,0.125W	91637	MFF1816D30400D
A1R450	321-0310-00			RES.,FXD,FILM:16.5K OHM,1%,0.125W	91637	MFF1816G16501F
A1R451	321-0275-00			RES.,FXD,FILM:7.15K OHM,1%,0.125W	91637	MFF1816G71500F
A1R452	321-0310-00			RES.,FXD,FILM:16.5K OHM,1%,0.125W	91637	MFF1816G16501F
A1R453	321-0275-00			RES.,FXD,FILM:7.15K OHM,1%,0.125W	91637	MFF1816G71500F
A1R454	321-0310-00			RES.,FXD,FILM:16.5K OHM,1%,0.125W	91637	MFF1816G16501F
A1R455	321-0309-00			RES.,FXD,FILM:16.2K OHM,1%,0.125W,TC=TO	91637	CMF55116G16201F
A1R456	321-0303-00	B010100	B019999	RES.,FXD,FILM:14K OHM,1%,0.125W	91637	MFF1816G14001F
A1R456	321-0329-00	B020000		RES.,FXD,FILM:26.1K OHM,1%,0.125W	91637	MFF1816G26101F
A1R457	321-0275-00			RES.,FXD,FILM:7.15K OHM,1%,0.125W	91637	MFF1816G71500F
A1R458	321-0085-00			RES.,FXD,FILM:75 OHM,1%,0.125W	91637	MFF1816G75R00F
A1R459	321-0085-00			RES.,FXD,FILM:75 OHM,1%,0.125W	91637	MFF1816G75R00F
A1R460	321-0062-00			RES.,FXD,FILM:43.2 OHM,1%,0.125W	91637	CMF55-116G43R20F
A1R461	321-0136-00	B010100	B019999	RES.,FXD,FILM:255 OHM,1%,0.125W	91637	MFF1816G255R0F
A1R461	321-0139-00	B020000		RES.,FXD,FILM:274 OHM,1%,0.125W	91637	MFF1816G274R0F
A1R462	321-0208-00	B010100	B019999	RES.,FXD,FILM:1.43K OHM,1%,0.125W	91637	MFF1816G14300F
A1R462	321-0201-00	B020000		RES.,FXD,FILM:1.21K OHM,1%,0.125W	91637	MFF1816G12100F
A1R463	321-0201-00	B010100	B019999	RES.,FXD,FILM:1.21K OHM,1%,0.125W	91637	MFF1816G12100F
A1R463	321-0193-00	B020000		RES.,FXD,FILM:1K OHM,1%,0.125W	91637	MFF1816G10000F
A1R464	321-0063-00			RES.,FXD,FILM:44.2 OHM,1%,0.125W	91637	MFF1816G44R20F
A1R465	321-0193-00			RES.,FXD,FILM:1K OHM,1%,0.125W	91637	MFF1816G10000F
A1R466	321-0275-00	B020000		RES.,FXD,FILM:7.15K OHM,1%,0.125W	91637	MFF1816G71500F
A1R470	315-0223-00			RES.,FXD,CMPSN:22K OHM,5%,0.25W	01121	CB2235
A1R471	315-0223-00			RES.,FXD,CMPSN:22K OHM,5%,0.25W	01121	CB2235
A1R476	315-0750-00			RES.,FXD,CMPSN:75 OHM,5%,0.25W	01121	CB7505
A1R477	315-0472-00			RES.,FXD,CMPSN:4.7K OHM,5%,0.25W	01121	CB4725
A1R478	321-0193-03			RES.,FXD,FILM:1K OHM,0.25%,0.125W	91637	MFF1816D10000C
A1R479	315-0102-00			RES.,FXD,CMPSN:1K OHM,5%,0.25W	01121	CB1025
A1R480	321-0378-00			RES.,FXD,FILM:84.5K OHM,1%,0.125W	91637	MFF1816G84501F
A1R481	321-0347-00			RES.,FXD,FILM:40.2K OHM,1%,0.125W	91637	MFF1816G40201F
A1R482	315-0471-00			RES.,FXD,CMPSN:470 OHM,5%,0.25W	01121	CB4715

Replaceable Electrical Parts—2445 Service

Component No.	Tektronix Part No.	Serial/Model No. Eff	Dscont	Name & Description	Mfr Code	Mfr Part Number
A1R483	321-0347-00			RES.,FXD,FILM:40.2K OHM,1%,0.125W	91637	MFF1816G40201F
A1R484	315-0202-00			RES.,FXD,CMPSN:2K OHM,5%,0.25W	01121	CB2025
A1R485	315-0202-00			RES.,FXD,CMPSN:2K OHM,5%,0.25W	01121	CB2025
A1R486	321-0347-00			RES.,FXD,FILM:40.2K OHM,1%,0.125W	91637	MFF1816G40201F
A1R487	321-0130-03			RES.,FXD,FILM:221 OHM,0.25%,0.125W	91637	MFF1816D221R0C
A1R488	321-1216-03			RES.,FXD,FILM:1.76K OHM,0.25%,0.125W	91637	MFF1816D17600C
A1R489	321-1216-03			RES.,FXD,FILM:1.76K OHM,0.25%,0.125W	91637	MFF1816D17600C
A1R490	321-0378-00			RES.,FXD,FILM:84.5K OHM,1%,0.125W	91637	MFF1816G84501F
A1R491	315-0102-00			RES.,FXD,CMPSN:1K OHM,5%,0.25W	01121	CB1025
A1R492	321-0193-03			RES.,FXD,FILM:1K OHM,0.25%,0.125W	91637	MFF1816D10000C
A1R493	315-0472-00			RES.,FXD,CMPSN:4.7K OHM,5%,0.25W	01121	CB4725
A1R494	315-0201-00			RES.,FXD,CMPSN:200 OHM,5%,0.25W	01121	CB2015
A1R495	315-0750-00			RES.,FXD,CMPSN:75 OHM,5%,0.25W	01121	CB7505
A1R497	315-0821-00			RES.,FXD,CMPSN:820 OHM,5%,0.25W	01121	CB8215
A1R498	315-0821-00			RES.,FXD,CMPSN:820 OHM,5%,0.25W	01121	CB8215
A1R500	315-0331-00			RES.,FXD,CMPSN:330 OHM,5%,0.25W	01121	CB3315
A1R501	315-0101-00			RES.,FXD,CMPSN:100 OHM<5%,0.25W	01121	CB1015
A1R502	315-0622-00			RES.,FXD,CMPSN:6.2K OHM,5%,0.25W	01121	CB6225
A1R503	315-0103-00	B020000		RES.,FXD,CMPSN:10K OHM,5%,0.25W	01121	CB1035
A1R504	315-0103-00	B020000		RES.,FXD,CMPSN:10K OHM,5%,0.25W	01121	CB1035
A1R511	321-0320-00	B010100	B019999	RES.,FXD,FILM:21K OHM,1%,0.125W	91637	MFF1816G21001F
A1R512	321-0293-00	B010100	B019999	RES.,FXD,FILM:11K OHM,1%,0.125W	91637	MFF1816G11001F
A1R513	315-0470-00			RES.,FXD,CMPSN:47 OHM,5%,0.25W	01121	CB4705
A1R518	315-0680-00			RES.,FXD,CMPSN:68 OHM,5%,0.25W	01121	CB6805
A1R519	315-0621-00			RES.,FXD,CMPSN:620 OHM,5%,0.25W	01121	CB6215
A1R520	315-0393-00			RES.,FXD,CMPSN:39K OHM,5%,0.25W	01121	CB3935
A1R521	315-0750-00			RES.,FXD,CMPSN:75 OHM,5%,0.25W	01121	CB7505
A1R527	315-0750-00			RES.,FXD,CMPSN:75 OHM,5%,0.25W	01121	CB7505
A1R529	315-0561-00			RES.,FXD,CMPSN:560 OHM,5%,0.25W	01121	CB5615
A1R537	315-0470-00			RES.,FXD,CMPSN:47 OHM,5%,0.25W	01121	CB4705
A1R542	315-0680-00			RES.,FXD,CMPSN:68 OHM,5%,0.25W	01121	CB6805
A1R543	315-0621-00			RES.,FXD,CMPSN:620 OHM,5%,0.25W	01121	CB6215
A1R544	315-0393-00			RES.,FXD,CMPSN:39K OHM,5%,0.25W	01121	CB3935
A1R545	315-0750-00			RES.,FXD,CMPSN:75 OHM,5%,0.25W	01121	CB7505
A1R550	315-0471-00			RES.,FXD,CMPSN:470 OHM,5%,0.25W	01121	CB4715
A1R551	321-1682-07			RES.,FXD,FILM:5.7K OHM,0.1%,0.125W	91637	MFF1816C57000B
A1R552	321-0641-07			RES.,FXD,FILM:1.8K OHM,0.1%,0.125W	91637	MFF1816C18000B
A1R553	315-0152-00			RES.,FXD,CMPSN:1.5K OHM,5%,0.25W	01121	CB1525
A1R554	315-0162-00			RES.,FXD,CMPSN:1.6K OHM,5%,0.25W	01121	CB1625
A1R555	321-0294-00			RES.,FXD,FILM:11.3K OHM,1%,0.125W	91637	CMF55116G11301F
A1R556	321-0282-00			RES.,FXD,FILM:8.45K OHM,1%,0.125W	91637	MFF1816G84500F
A1R557	321-0808-07			RES.,FXD,FILM:300 OHM,0.1%,0.125W	24546	NE55E3000B
A1R558	321-0657-07			RES.,FXD,FILM:60 OHM,0.1%,0.125W	91637	CMF55-116C60R00B
A1R560	315-0621-00			RES.,FXD,CMPSN:620 OHM,5%,0.25W	01121	CB6215
A1R600	315-0270-00			RES.,FXD,CMPSN:27 OHM,5%,0.25W	01121	CB2705
A1R601	307-0108-00			RES.,FXD,CMPSN:6.8 OHM,5%,0.25W	01121	CB68G5
A1R602	307-0108-00			RES.,FXD,CMPSN:6.8 OHM,5%,0.25W	01121	CB68G5
A1R605	321-0112-00			RES.,FXD,FILM:143 OHM,1%,0.125W	91637	MFF1816G143R0F
A1R606	321-0002-00			RES.,FXD,FILM:10.2 OHM,1%,0.125W	91637	MFF1816G10R20F
A1R607	321-0002-00			RES.,FXD,FILM:10.2 OHM,1%,0.125W	91637	MFF1816G10R20F
A1R608	307-0108-00			RES.,FXD,CMPSN:6.8 OHM,5%,0.25W	01121	CB68G5
A1R614	315-0103-00			RES.,FXD,CMPSN:10K OHM,5%,0.25W	01121	CB1035
A1R615	315-0103-00			RES.,FXD,CMPSN:10K OHM,5%,0.25W	01121	CB1035
A1R617	315-0102-00			RES.,FXD,CMPSN:1K OHM,5%,0.25W	01121	CB1025
A1R618	311-1137-00			RES.,VAR, NONWIR:5K OHM,20%,0.50W	73138	72PX-67-0-502M

Replaceable Electrical Parts—2445 Service

Component No.	Tektronix Part No.	Serial/Model No. Eff	Dscont	Name & Description	Mfr Code	Mfr Part Number
A1R619	315-0270-00			RES.,FXD,CMPSN:27 OHM,5%,0.25W	01121	CB2705
A1R620	315-0472-00	B011400		RES.,FXD,CMPSN:4.7K OHM,5%,0.25W	01121	CB4725
A1R622	321-0226-00	B010100	B019999	RES.,FXD,FILM:2.21K OHM,1%,0.125W	91637	MFF1816G22100F
A1R622	321-0255-00	B020000		RES.,FXD,CMPSN:4.42K OHM,1%,0.125W	91637	MFF1816G44200F
A1R624	315-0100-00			RES.,FXD,CMPSN:10 OHM,5%,0.25W	01121	CB1005
A1R638	311-1137-00			RES.,VAR,NONWIR:5K OHM,20%,0.50W	73138	72PX-67-0-502M
A1R639	311-2099-00			RES.,VAR,NONWIR:TRMR,500 OHM,10%,0.5W	73138	72PXR500-266A
A1R639	-----			(IN SERIES W/W639)		
A1R642	315-0432-00			RES.,FXD,CMPSN:4.3K OHM,5%,0.25W	01121	CB4325
A1R643	315-0750-00			RES.,FXD,CMPSN:75 OHM,5%,0.25W	01121	CB7505
A1R644	315-0472-00			RES.,FXD,CMPSN:4.7K OHM,5%,0.25W	01121	CB4725
A1R645	321-0625-00			RES.,FXD,FILM:5.88K OHM,1%,0.125W	91637	MFF1816G58800F
A1R646	321-0252-00			RES.,FXD,FILM:4.12K OHM,1%,0.125W	91637	MFF1816G41200F
A1R650	315-0203-00			RES.,FXD,CMPSN:20K OHM,5%,0.25W	01121	CB2035
A1R651	315-0911-00			RES.,FXD,CMPSN:910 OHM,5%,0.25W	01121	CB9115
A1R652	315-0274-00			RES.,FXD,CMPSN:270K OHM,5%,0.25W	01121	CB2745
A1R653	315-0102-00			RES.,FXD,CMPSN:1K OHM,5%,0.25W	01121	CB1025
A1R654	315-0911-00			RES.,FXD,CMPSN:910 OHM,5%,0.25W	01121	CB9115
A1R655	315-0102-00			RES.,FXD,CMPSN:1K OHM,5%,0.25W	01121	CB1025
A1R669	321-0406-00			RES.,FXD,FILM:165K OHM,1%,0.125W	91637	MFF1816G16502F
A1R670	315-0102-00			RES.,FXD,CMPSN:1K OHM,5%,0.25W	01121	CB1025
A1R671	315-0103-00			RES.,FXD,CMPSN:10K OHM,5%,0.25W	01121	CB1035
A1R672	315-0102-00			RES.,FXD,CMPSN:1K OHM,5%,0.25W	01121	CB1025
A1R678	315-0102-00			RES.,FXD,CMPSN:1K OHM,5%,0.25W	01121	CB1025
A1R700	315-0221-00			RES.,FXD,CMPSN:220 OHM,5%,0.25W	01121	CB2215
A1R701	321-0223-00			RES.,FXD,FILM:2.05K OHM,1%,0.125W	91637	MFF1816G20500F
A1R702	321-0252-00			RES.,FXD,FILM:4.12K OHM,1%,0.125W	91637	MFF1816G41200F
A1R707	315-0122-00			RES.,FXD,CMPSN:1.2K OHM,5%,0.25W	01121	CB1225
A1R708	315-0242-00			RES.,FXD,CMPSN:2.4K OHM,5%,0.25W	01121	CB2425
A1R709	315-0472-00			RES.,FXD,CMPSN:4.7K OHM,5%,0.25W	01121	CB4725
A1R710	315-0396-00			RES.,FXD,CMPSN:39M OHM,5%,0.25W	01121	CB3965
A1R713	315-0822-00			RES.,FXD,CMPSN:8.2K OHM,5%,0.25W	01121	CB8225
A1R723	321-0245-00			RES.,FXD,FILM:3.48K OHM,1%,0.125W	91637	MFF1816G34800F
A1R724	321-0680-00			RES.,FXD,FILM:35.3K OHM,0.5%,0.125W	91637	MFF1816D35301D
A1R731	315-0153-00			RES.,FXD,CMPSN:15K OHM,5%,0.25W	01121	CB1535
A1R732	315-0682-00			RES.,FXD,CMPSN:6.8K OHM,5%,0.25W	01121	CB6825
A1R733	315-0182-00			RES.,FXD,CMPSN:1.8K OHM,5%,0.25W	01121	CB1825
A1R734	315-0221-00			RES.,FXD,CMPSN:220 OHM,5%,0.25W	01121	CB2215
A1R735	315-0273-00			RES.,FXD,CMPSN:27K OHM,5%,0.25W	01121	CB2735
A1R736	321-0209-00	B010100	B019999	RES.,FXD,FILM:1.47K OHM,1%,0.125W	91637	MFF1816G14700F
A1R736	321-0197-00	B020000		RES.,FXD,FILM:1.1K OHM,1%,0.125W	91637	MFF1816G11000F
A1R737	321-0255-00	B010100	B019999	RES.,FXD,FILM:4.42K OHM,1%,0.125W	91637	MFF1816G44200F
A1R738	321-0273-00			RES.,FXD,FILM:6.81K OHM,1%,0.125W	91637	MFF1816G68100F
A1R741	315-0272-00			RES.,FXD,CMPSN:2.7K OHM,5%,0.25W	01121	CB2725
A1R742	315-0151-00			RES.,FXD,CMPSN:150 OHM,5%,0.25W	01121	CB1515
A1R743	315-0750-00	B010100	B019999	RES.,FXD,CMPSN:75 OHM,5%,0.25W	01121	CB7505
A1R743	315-0102-00	B020000		RES.,FXD,CMPSN:1K OHM,5%,0.25W	01121	CB1025
A1R744	315-0750-00			RES.,FXD,CMPSN:75 OHM,5%,0.25W	01121	CB7505
A1R745	315-0242-00			RES.,FXD,CMPSN:2.4K OHM,5%,0.25W	01121	CB2425
A1R746	301-0470-00			RES.,FXD,CMPSN:47 OHM,5%,0.5W	01121	EB4705
A1R750	315-0271-00			RES.,FXD,CMPSN:270 OHM,5%,0.25W	01121	CB2715
A1R800	321-0147-00			RES.,FXD,FILM:332 OHM,1%,0.125W	91637	MFF1816G332R0F
A1R801	311-2099-00			RES.,VAR,NONWIR:TRMR,500 OHM,10%,0.5W	73138	72PXR500-266A
A1R801	-----			(IN SERIES W/W800)		

Replaceable Electrical Parts—2445 Service

Component No.	Tektronix Part No.	Serial/Model No. Eff	Dscont	Name & Description	Mfr Code	Mfr Part Number
A1R802	315-0222-00	B010100	B019999	RES.,FXD,CMPSN:2.2K OHM,5%,0.25W	01121	CB2225
A1R802	315-0821-00	B020000		RES.,FXD,CMPSN:820 OHM,5%,0.25W	01121	CB8215
A1R803	315-0821-00	B010100	B019999	RES.,FXD,CMPSN:820 OHM,5%,0.25W	01121	CB8215
A1R803	315-0222-00	B020000		RES.,FXD,CMPSN:2.2K OHM,5%,0.25W	01121	CB2225
A1R804	315-0151-00			RES.,FXD,CMPSN:150 OHM,5%,0.25W	01121	CB1515
A1R805	311-2155-00	B010100	B019999	RES.,VAR,NONWIR:RMR,200K OHM,10%,0.5W	73138	72PXR200K
A1R805	311-1242-00	B020000		RES.,VAR,NONWIR:200K OHM,10%,0.50W	73138	72-33-0
A1R806	315-0204-00			RES.,FXD,CMPSN:200K OHM,5%,0.25W	01121	CB2045
A1R809	315-0151-00			RES.,FXD,CMPSN:150 OHM,5%,0.25W	01121	CB1515
A1R811	301-0331-00			RES.,FXD,CMPSN:330 OHM,5%,0.5W	01121	EB3315
A1R817	315-0221-00			RES.,FXD,CMPSN:220 OHM,5%,0.25W	01121	CB2215
A1R820	321-0327-00			RES.,FXD,FILM:24.9K OHM,1%,0.125W	91637	MFF1816G24901F
A1R821	321-0298-00			RES.,FXD,FILM:12.4K OHM,1%,0.125W	91637	MFF1816G12401F
A1R822	315-0271-00			RES.,FXD,CMPSN:270 OHM,5%,0.25W	01121	CB2715
A1R823	321-0193-00			RES.,FXD,FILM:1K OHM,1%,0.125W	91637	MFF1816G10000F
A1R839	321-0147-00			RES.,FXD,FILM:332 OHM,1%,0.125W	91637	MFF1816G332R0F
A1R850	311-1137-00			RES.,VAR,NONWIR:5K OHM,20%,0.50W	73138	72PX-67-0-502M
A1R852	315-0240-00			RES.,FXD,CMPSN:24 OHM,5%,0.25W	01121	CB2405
A1R853	315-0240-00			RES.,FXD,CMPSN:24 OHM,5%,0.25W	01121	CB2405
A1R855	315-0103-00			RES.,FXD,CMPSN:10K OHM,5%,0.25W	01121	CB1035
A1R856	321-0210-00			RES.,FXD,FILM:1.5K OHM,1%,0.125W	91637	MFF1816G15000F
A1R858	321-0239-00			RES.,FXD,FILM:3.01K OHM,1%,0.125W	91637	MFF1816G30100F
A1R860	311-1137-00			RES.,VAR,NONWIR:5K OHM,20%,0.50W	73138	72PX-67-0-502M
A1R901	315-0112-00	B020000		RES.,FXD,CMPSN:1.1K OHM,5%,0.25W	01121	CB1125
A1R902	315-0112-00	B020000		RES.,FXD,CMPSN:1.1K OHM,5%,0.25W	01121	CB1125
A1R903	315-0472-00	B020000		RES.,FXD,CMPSN:4.7K OHM,5%,0.25W	01121	CB4725
A1R904	315-0124-00			RES.,FXD,CMPSN:120K OHM,5%,0.25W	01121	CB1245
A1R907	315-0471-00			RES.,FXD,CMPSN:470 OHM,5%,0.25W	01121	CB4715
A1R910	315-0396-00			RES.,FXD,CMPSN:39M OHM,5%,0.25W	01121	CB3965
A1R912	315-0822-00			RES.,FXD,CMPSN:8.2K OHM,5%,0.25W	01121	CB8225
A1R924	321-0325-00			RES.,FXD,FILM:23.7K OHM,1%,0.125W	91637	MFF1816G23701F
A1R936	321-0217-00			RES.,FXD,FILM:1.78K OHM,1%,0.125W	91637	MFF1816G17800F
A1R937	321-0268-00			RES.,FXD,FILM:6.04K OHM,1%,0.125W	91637	MFF1816G60400F
A1R939	315-0332-00	B020000		RES.,FXD,CMPSN:3.3K OHM,5%,0.25W	01121	CB3325
A1R940	315-0101-00			RES.,FXD,CMPSN:100 OHM<5%,0.25W	01121	CB1015
A1R941	315-0102-00	B010100	B019999	RES.,FXD,CMPSN:1K OHM,5%,0.25W	01121	CB1025
A1R941	315-0561-00	B020000		RES.,FXD,CMPSN:560 OHM,5%,0.25W	01121	CB5615
A1R942	321-0256-00	B020000		RES.,FXD,FILM:4.53K OHM,1%,0.125W	91637	MFF1816G45300F
A1R943	315-0121-00			RES.,FXD,CMPSN:120 OHM,5%,0.25W	01121	CB1215
A1R944	317-0302-00			RES.,FXD,CMPSN:3K OHM,5%,0.125W	01121	BB3025
A1R945	315-0621-00			RES.,FXD,CMPSN:620 OHM,5%,0.25W	01121	CB6215
A1R950	301-0470-00			RES.,FXD,CMPSN:47 OHM,5%,0.5W	01121	EB4705
A1R951	308-0555-00			RES.,FXD,WW:5 OHM,5%,3W	00213	1200S-5R000J
A1R952	315-0750-00			RES.,FXD,CMPSN:75 OHM,5%,0.25W	01121	CB7505
A1R956	315-0302-00			RES.,FXD,CMPSN:3K OHM,5%,0.25W	01121	CB3025
A1R957	321-0291-00			RES.,FXD,FILM:10.5K OHM,1%,0.125W	91637	MFF1816G10501F
A1R972	315-0510-00			RES.,FXD,CMPSN:51 OHM,5%,0.25W	01121	CB5105
A1R973	315-0513-00			RES.,FXD,CMPSN:51K OHM,5%,0.25W	01121	CB5135
A1R981	315-0101-00			RES.,FXD,CMPSN:100 OHM<5%,0.25W	01121	CB1015
A1R995	315-0512-00			RES.,FXD,CMPSN:5.1K OHM,5%,0.25W	01121	CB5125
A1S615	260-1421-00			SWITCH,PUSH:1 STA,MOMENTARY,NON-SHORT	59821	OBD
A1U100	155-0235-00	B010100	B013249	MICROCIRCUIT,LI:VERTICAL PREAMP,TESTED	80009	155-0235-00
A1U100	153-0235-00	B013250		MICROCIRCUIT,LI:VERTICAL PREAMPS	80009	153-0235-00
A1U100	-----			(PART OF A1U200)		

Replaceable Electrical Parts—2445 Service

Component No.	Tektronix Part No.	Serial/Model No. Eff	Dscnt	Name & Description	Mfr Code	Mfr Part Number
A1U110	156-1245-00			MICROCIRCUIT,LI:7 XSTR,HV/HIGH CUR	04713	MC1413PDS
A1U120	156-1245-00			MICROCIRCUIT,LI:7 XSTR,HV/HIGH CUR	04713	MC1413PDS
A1U130	156-1245-00			MICROCIRCUIT,LI:7 XSTR,HV/HIGH CUR	04713	MC1413PDS
A1U140	156-0651-02			MICROCIRCUIT,DI:8 BIT PRL-OUT SER SHF RGTR	01295	SN74LS164(NP3 OR
A1U150	156-0651-02			MICROCIRCUIT,DI:8 BIT PRL-OUT SER SHF RGTR	01295	SN74LS164(NP3 OR
A1U160	156-1200-01			MICROCIRCUIT,LI:OPERATIONAL AMPL,QUAD	01295	TL074CN/PEP3
A1U165	156-0495-02			MICROCIRCUIT,LI:QUAD OPNL AMPL,SELECTED	01295	LM324J4
A1U170	156-0513-03			MICROCIRCUIT,LI:CMOS,8 CHAN ANALOG MU	80009	156-0513-03
A1U200	155-0235-00	B010100	B013249	MICROCIRCUIT,LI:VERTICAL PREAMP,TESTED	80009	155-0235-00
A1U200	153-0235-00	B013250		MICROCIRCUIT,LI:VERTICAL PREAMPS	80009	153-0235-00
A1U200	-----			(PART OF A1U100)		
A1U300	155-0238-00			MICROCIRCUIT,LI:TRIGGER PREAMP	80009	155-0238-00
A1U350	156-0853-02			MICROCIRCUIT,LI:DUAL OPNL AMPL,CHK	04713	LM358J
A1U400	155-0236-00			MICROCIRCUIT,LI:VERTICAL CHANNEL SWITCH	80009	155-0236-00
A1U450	156-0158-07			MICROCIRCUIT,LI:DUAL OPNL AMPL,SCREENED	01295	MC1458JG4
A1U475	156-0048-00			MICROCIRCUIT,LI:FIVE NPN TRANSISTOR ARRAY	02735	CA3046
A1U485	156-0048-00			MICROCIRCUIT,LI:FIVE NPN TRANSISTOR ARRAY	02735	CA3046
A1U500	155-0239-01			MICROCIRCUIT,LI:TRIGGER,W/THRU HOLE	80009	155-0239-01
A1U550	156-0048-00			MICROCIRCUIT,LI:FIVE NPN TRANSISTOR ARRAY	02735	CA3046
A1U600	155-0237-00			MICROCIRCUIT,LI:VERTICAL OUTPUT,TESTED	80009	155-0237-00
A1U650	155-0244-00			MICROCIRCUIT,DI:SYSTEM LOGIC INTERFACE		
A1U700	155-0240-00			MICROCIRCUIT,LI:Z AXIS AUTOFOCUS,TESTED	80009	155-0240-00
A1U735	156-0048-00			MICROCIRCUIT,LI:FIVE NPN TRANSISTOR ARRAY	02735	CA3046
A1U800	155-0241-01			MICROCIRCUIT,LI:HORIZONTAL AMPLIFIER	80009	155-0241-01
A1U850	156-0515-02			MICROCIRCUIT,DI:TRIPLE 3-CHAN MUX,SEL	80009	156-0515-02
A1U860	156-0515-02			MICROCIRCUIT,DI:TRIPLE 3-CHAN MUX,SEL	80009	156-0515-02
A1U900	155-0240-00			MICROCIRCUIT,LI:VERTICAL OUTPUT,TESTED	80009	155-0240-00
A1U910	156-1191-01			MICROCIRCUIT,LI:DUAL BI-FET OP-AMP,8 DIP	01295	TL072ACP3
A1U950	155-0242-00	B010100	B011099	MICROCIRCUIT,LI:Z AXIS AUTOFOCUS,TESTED	80009	155-0242-00
A1U950	155-0242-01	B011100		MICROCIRCUIT,LI:Z AXIS AUTOFOCUS,TESTED	80009	155-0242-01
A1U975	156-0382-02			MICROCIRCUIT,DI:QUAD 2-INP NAND GATE	01295	SN74LS00
A1U980	156-0479-02			MICROCIRCUIT,DI:QUAD 2-INP OR GATE	01295	SN74LS32NP3
A1VR125	152-0166-00			SEMICONV DEVICE:ZENER,0.4W,6.2V,5%	04713	SZ11738RL
A1VR225	152-0166-00			SEMICONV DEVICE:ZENER,0.4W,6.2V,5%	04713	SZ11738RL
A1VR550	152-0195-00			SEMICONV DEVICE:ZENER,0.4W,5.1V,5%	04713	SZ11755
A1W101	131-0566-00			BUS CONDUCTOR:DUMMY RES,2.375,22 AWG	57668	JWW-0200E0
A1W103	131-0566-00			BUS CONDUCTOR:DUMMY RES,2.375,22 AWG	57668	JWW-0200E0
A1W104	131-0566-00			BUS CONDUCTOR:DUMMY RES,2.375,22 AWG	57668	JWW-0200E0
A1W105	131-0566-00			BUS CONDUCTOR:DUMMY RES,2.375,22 AWG	57668	JWW-0200E0
A1W106	131-0566-00			BUS CONDUCTOR:DUMMY RES,2.375,22 AWG	57668	JWW-0200E0
A1W107	131-0566-00			BUS CONDUCTOR:DUMMY RES,2.375,22 AWG	57668	JWW-0200E0
A1W121	175-4594-00			CA ASSY,SP,ELEC:7,22 AWG,7.0 L,RIBBON	80009	175-4594-00
A1W122	175-4598-00			CA ASSY,SP,ELEC:8,26 AWG,7.0 L,RIBBON	80009	175-4598-00
A1W171	131-0566-00			BUS CONDUCTOR:DUMMY RES,2.375,22 AWG	57668	JWW-0200E0
A1W172	131-0566-00			BUS CONDUCTOR:DUMMY RES,2.375,22 AWG	57668	JWW-0200E0
A1W194	131-0566-00	B010100	B019999	BUS CONDUCTOR:DUMMY RES,2.375,22 AWG	57668	JWW-0200E0
A1W666	131-0566-00			BUS CONDUCTOR:DUMMY RES,2.375,22 AWG	57668	JWW-0200E0
A1W677	131-0566-00			BUS CONDUCTOR:DUMMY RES,2.375,22 AWG	57668	JWW-0200E0

Replaceable Electrical Parts—2445 Service

Component No.	Tektronix Part No.	Serial/Model No. Eff Dscont	Name & Description	Mfr Code	Mfr Part Number
A2	-----		CKT BOARD ASSY:REGULATOR		
A2	-----		(AVAILABLE AT 672-1037-XX LEVEL ONLY)		
A2C1016	285-1222-00		CAP.,FXD,PLSTC:0.068UF,20%,250V	55112	158/.068/M/250/H
A2C1018	285-1222-00		CAP.,FXD,PLSTC:0.068UF,20%,250V	55112	158/.068/M/250/H
A2C1208	281-0775-00		CAP.,FXD,CER DI:0.1UF,20%,50V	04222	MA205E104MAA
A2C1220	290-0939-00		CAP.,FXD,ELCTL:10UF,+100-10%,100V	56289	672D106H100CG2C
A2C1226	281-0791-00		CAP.,FXD,CER DI:270PF,10%,100V	04222	MA101A271KAA
A2C1240	290-0939-00		CAP.,FXD,ELCTL:10UF,+100-10%,100V	56289	672D106H100CG2C
A2C1245	281-0783-00		CAP.,FXD,CER DI:0.1UF,20%,100V	96733	ADVISE
A2C1246	281-0791-00		CAP.,FXD,CER DI:270PF,10%,100V	04222	MA101A271KAA
A2C1260	290-0942-00		CAP.,FXD,ELCTL:100UF,+100-10%,25V	56289	672D107H025CG2C
A2C1261	281-0773-00		CAP.,FXD,CER DI:0.01UF,10%,100V	04222	MA201C103KAA
A2C1270	281-0791-00		CAP.,FXD,CER DI:270PF,10%,100V	04222	MA101A271KAA
A2C1272	281-0774-00		CAP.,FXD,CER DI:0.022UF,20%,100V	12969	CGE223MEZ
A2C1274	290-0778-00		CAP.,FXD,ELCTL:1UF,+50-10%,50V	54473	ECE-A50N1
A2C1280	290-0942-00		CAP.,FXD,ELCTL:100UF,+100-10%,25V	56289	672D107H025CG2C
A2C1290	281-0775-00		CAP.,FXD,CER DI:0.1UF,20%,50V	04222	MA205E104MAA
A2C1291	290-0778-00		CAP.,FXD,ELCTL:1UF,+50-10%,50V	54473	ECE-A50N1
A2C1300	290-0942-00		CAP.,FXD,ELCTL:100UF,+100-10%,25V	56289	672D107H025CG2C
A2C1330	290-0942-00		CAP.,FXD,ELCTL:100UF,+100-10%,25V	56289	672D107H025CG2C
A2C1331	281-0775-00		CAP.,FXD,CER DI:0.1UF,20%,50V	04222	MA205E104MAA
A2C1350	290-0942-00		CAP.,FXD,ELCTL:100UF,+100-10%,25V	56289	672D107H025CG2C
A2C1357	281-0773-00		CAP.,FXD,CER DI:0.01UF,10%,100V	04222	MA201C103KAA
A2C1374	281-0791-00		CAP.,FXD,CER DI:270PF,10%,100V	04222	MA101A271KAA
A2C1400	290-0943-00		CAP.,FXD,ELCTL:47UF,+50-10%,25V	55680	ULB1E470TECANA
A2C1402	290-0943-00		CAP.,FXD,ELCTL:47UF,+50-10%,25V	55680	ULB1E470TECANA
A2CR1011	152-0750-00		SEMICONV DEVICE:RECT BRIDGE,600V,3A	80009	152-0750-00
A2CR1220	152-0066-00		SEMICONV DEVICE:SILICON,400V,750MA	14433	LG4016
A2CR1221	152-0066-00		SEMICONV DEVICE:SILICON,400V,750MA	14433	LG4016
A2CR1241	152-0066-00		SEMICONV DEVICE:SILICON,400V,750MA	14433	LG4016
A2CR1242	152-0066-00		SEMICONV DEVICE:SILICON,400V,750MA	14433	LG4016
A2CR1243	152-0066-00		SEMICONV DEVICE:SILICON,400V,750MA	14433	LG4016
A2CR1244	152-0066-00		SEMICONV DEVICE:SILICON,400V,750MA	14433	LG4016
A2CR1260	152-0066-00		SEMICONV DEVICE:SILICON,400V,750MA	14433	LG4016
A2CR1261	152-0066-00		SEMICONV DEVICE:SILICON,400V,750MA	14433	LG4016
A2CR1262	152-0141-02		SEMICONV DEVICE:SILICON,30V,150MA	01295	1N4152R
A2CR1263	152-0141-02		SEMICONV DEVICE:SILICON,30V,150MA	01295	1N4152R
A2CR1264	152-0141-02		SEMICONV DEVICE:SILICON,30V,150MA	01295	1N4152R
A2CR1281	152-0141-02		SEMICONV DEVICE:SILICON,30V,150MA	01295	1N4152R
A2CR1282	152-0141-02		SEMICONV DEVICE:SILICON,30V,150MA	01295	1N4152R
A2CR1283	152-0066-00		SEMICONV DEVICE:SILICON,400V,750MA	14433	LG4016
A2CR1300	152-0141-02		SEMICONV DEVICE:SILICON,30V,150MA	01295	1N4152R
A2CR1301	152-0141-02		SEMICONV DEVICE:SILICON,30V,150MA	01295	1N4152R
A2CR1302	152-0141-02		SEMICONV DEVICE:SILICON,30V,150MA	01295	1N4152R
A2CR1303	152-0066-00		SEMICONV DEVICE:SILICON,400V,750MA	14433	LG4016
A2CR1330	152-0066-00		SEMICONV DEVICE:SILICON,400V,750MA	14433	LG4016
A2CR1331	152-0066-00		SEMICONV DEVICE:SILICON,400V,750MA	14433	LG4016
A2CR1332	152-0066-00		SEMICONV DEVICE:SILICON,400V,750MA	14433	LG4016
A2CR1334	152-0066-00		SEMICONV DEVICE:SILICON,400V,750MA	14433	LG4016
A2CR1351	152-0066-00		SEMICONV DEVICE:SILICON,400V,750MA	14433	LG4016
A2CR1376	152-0141-02		SEMICONV DEVICE:SILICON,30V,150MA	01295	1N4152R
A2E1001	119-0181-00		ARSR,ELEC SURGE:230V,GAS FILLED	74276	CG230L
A2E1002	119-0181-00		ARSR,ELEC SURGE:230V,GAS FILLED	74276	CG230L

Replaceable Electrical Parts—2445 Service

Component No.	Tektronix Part No.	Serial/Model No. Eff Dscont	Name & Description	Mfr Code	Mfr Part Number
A2F1330	159-0185-00		FUSE,CARTRIDGE:5.2 X 20MM,0.75A,125V	000HX	TSC.75
A2J203	131-2925-00	B020000	CONN,RCPT,ELEC:CKT BD,1X6,0.2 SPACING	27264	10-10-1069
A2L1011	108-0473-00		COIL,RF:150UH	80009	108-0473-00
A2L1012	108-0473-00		COIL,RF:150UH	80009	108-0473-00
A2L1402	108-0443-00		COIL,RF:25UH	80009	108-0443-00
A2P204	131-1048-00		TERM.QIK DISC:CKT BD MT,0.11 X 0.02	00779	61134-1
A2P205	131-1048-00		TERM.QIK DISC:CKT BD MT,0.11 X 0.02	00779	61134-1
A2P206	131-1048-00		TERM.QIK DISC:CKT BD MT,0.11 X 0.02	00779	61134-1
A2P207	131-1048-00		TERM.QIK DISC:CKT BD MT,0.11 X 0.02	00779	61134-1
A2Q1220	151-0497-00		TRANSISTOR:SILICON,NPN	04713	SJE1985
A2Q1221	151-0347-00		TRANSISTOR:SILICON,NPN	56289	2N5551
A2Q1222	151-0347-00		TRANSISTOR:SILICON,NPN	56289	2N5551
A2Q1223	151-0347-00		TRANSISTOR:SILICON,NPN	56289	2N5551
A2Q1240	151-0464-00		TRANSISTOR:SILICON,NPN	04713	SJE412
A2Q1241	151-0347-00		TRANSISTOR:SILICON,NPN	56289	2N5551
A2Q1243	151-0347-00		TRANSISTOR:SILICON,NPN	56289	2N5551
A2Q1245	151-0347-00		TRANSISTOR:SILICON,NPN	56289	2N5551
A2Q1280	151-0476-00		TRANSISTOR:SILICON,NPN	02735	68430
A2Q1281	151-0347-00		TRANSISTOR:SILICON,NPN	56289	2N5551
A2Q1300	151-0482-00		TRANSISTOR:SILICON,PNP	80009	151-0482-00
A2Q1301	151-0342-00		TRANSISTOR:SILICON,PNP	07263	S035928
A2Q1351	151-0429-00		TRANSISTOR:SILICON,PNP	04713	SJE957
A2Q1354	151-0342-00		TRANSISTOR:SILICON,PNP	07263	S035928
A2Q1370	151-0341-00		TRANSISTOR:SILICON,NPN	07263	S040065
A2Q1376	151-0341-00		TRANSISTOR:SILICON,NPN	07263	S040065
A2R1011	315-0560-00		RES.,FXD,CMPSN:56 OHM,5%,0.25W	01121	CB5605
A2R1012	315-0560-00		RES.,FXD,CMPSN:56 OHM,5%,0.25W	01121	CB5605
A2R1013	315-0154-00		RES.,FXD,CMPSN:150K OHM,5%,0.25W	01121	CB1545
A2R1014	315-0753-00		RES.,FXD,CMPSN:75K OHM,5%,0.25W	01121	CB7535
A2R1015	315-0753-00		RES.,FXD,CMPSN:75K OHM,5%,0.25W	01121	CB7535
A2R1016	301-0680-00		RES.,FXD,CMPSN:68 OHM,5%,0.50W	01121	EB6805
A2R1017	315-0474-00		RES.,FXD,CMPSN:470K OHM,5%,0.25W	01121	CB4745
A2R1018	301-0300-00		RES.,FXD,CMPSN:30 OHM,5%,0.5W	01121	EB3005
A2R1204	315-0103-00		RES.,FXD,CMPSN:10K OHM,5%,0.25W	01121	CB1035
A2R1208	315-0471-00		RES.,FXD,CMPSN:470 OHM,5%,0.25W	01121	CB4715
A2R1212	315-0393-00		RES.,FXD,CMPSN:39K OHM,5%,0.25W	01121	CB3935
A2R1220	304-0822-00		RES.,FXD,CMPSN:8.2K OHM,10%,1W	01121	GB8221
A2R1221	315-0100-00		RES.,FXD,CMPSN:10 OHM,5%,0.25W	01121	CB1005
A2R1222	315-0102-00		RES.,FXD,CMPSN:1K OHM,5%,0.25W	01121	CB1025
A2R1223	315-0823-00		RES.,FXD,CMPSN:82K OHM,5%,0.25W	01121	CB8235
A2R1226	315-0472-00		RES.,FXD,CMPSN:4.7K OHM,5%,0.25W	01121	CB4725
A2R1227	321-0634-00		RES.,FXD,FILM:84.65K OHM,0.25%,0.125W	91637	CMF55-116D84651C
A2R1228	321-0293-03		RES.,FXD,FILM:11K OHM,0.25%,0.125W	24546	NC55C1102C
A2R1229	315-0683-00		RES.,FXD,CMPSN:68K OHM,5%,0.25W	01121	CB6835
A2R1240	303-0202-00		RES.,FXD,CMPSN:2K OHM,5%,1W	01121	GB2025
A2R1241	307-0105-00		RES.,FXD,CMPSN:3.9 OHM,5%,0.25W	01121	CB39G5
A2R1242	315-0152-00		RES.,FXD,CMPSN:1.5K OHM,5%,0.25W	01121	CB1525
A2R1243	315-0393-00		RES.,FXD,CMPSN:39K OHM,5%,0.25W	01121	CB3935
A2R1244	315-0104-00		RES.,FXD,CMPSN:100K OHM,5%,0.25W	01121	CB1045

Replaceable Electrical Parts—2445 Service

Component No.	Tektronix Part No.	Serial/Model No. Eff Dscont	Name & Description	Mfr Code	Mfr Part Number
A2R1246	315-0472-00		RES.,FXD,CMPSN:4.7K OHM,5%,0.25W	01121	CB4725
A2R1247	321-0368-00		RES.,FXD,FILM:66.5K OHM,1%,0.125W	91637	MFF1816G66501F
A2R1248	321-0319-00		RES.,FXD,FILM:20.5K OHM,1%,0.125W	91637	MFF1816G20501F
A2R1249	315-0473-00		RES.,FXD,CMPSN:47K OHM,5%,0.25W	01121	CB4735
A2R1261	321-0289-00		RES.,FXD,FILM:10K OHM,1%,0.125W	91637	MFF1816G10001F
A2R1262	321-0318-00		RES.,FXD,FILM:20K OHM,1%,0.125W	91637	MFF1816G20001F
A2R1264	315-0473-00		RES.,FXD,CMPSN:47K OHM,5%,0.25W	01121	CB4735
A2R1270	315-0432-00		RES.,FXD,CMPSN:4.3K OHM,5%,0.25W	01121	CB4325
A2R1273	315-0473-00		RES.,FXD,CMPSN:47K OHM,5%,0.25W	01121	CB4735
A2R1274	315-0753-00		RES.,FXD,CMPSN:75K OHM,5%,0.25W	01121	CB7535
A2R1280	303-0470-00		RES.,FXD,CMPSN:47 OHM,5%,1W	01121	GB4705
A2R1281	308-0839-00		RES.,FXD,WW:0.1 OHM,5%,1.0W	75042	BW-20-R/1000J
A2R1282	315-0102-00		RES.,FXD,CMPSN:1K OHM,5%,0.25W	01121	CB1025
A2R1283	315-0103-00		RES.,FXD,CMPSN:10K OHM,5%,0.25W	01121	CB1035
A2R1284	321-0318-00		RES.,FXD,FILM:20K OHM,1%,0.125W	91637	MFF1816G20001F
A2R1285	321-0318-00		RES.,FXD,FILM:20K OHM,1%,0.125W	91637	MFF1816G20001F
A2R1286	315-0243-00		RES.,FXD,CMPSN:24K OHM,5%,0.25W	01121	CB2435
A2R1291	321-0334-00		RES.,FXD,FILM:29.4K OHM,1%,0.125W	91637	MFF1816G29401F
A2R1292	311-1138-00		RES.,VAR, NONWIR:1K OHM,20%,0.50W	73138	72XW-44-0-102M
A2R1293	321-0639-00		RES.,FXD,FILM:9.6K OHM,1%,0.125W	91637	MFF1816G96000F
A2R1300	303-0470-00		RES.,FXD,CMPSN:47 OHM,5%,1W	01121	GB4705
A2R1301	308-0839-00		RES.,FXD,WW:0.1 OHM,5%,1.0W	75042	BW-20-R/1000J
A2R1302	315-0102-00		RES.,FXD,CMPSN:1K OHM,5%,0.25W	01121	CB1025
A2R1304	315-0243-00		RES.,FXD,CMPSN:24K OHM,5%,0.25W	01121	CB2435
A2R1305	321-0289-06		RES.,FXD,FILM:10K OHM,0.25%,0.125W	91637	MFF1816C10001C
A2R1306	321-0318-03		RES.,FXD,FILM:20K OHM,0.25%,0.125W	24546	NC55C2002C
A2R1307	315-0472-00		RES.,FXD,CMPSN:4.7K OHM,5%,0.25W	01121	CB4725
A2R1309	315-0222-00		RES.,FXD,CMPSN:2.2K OHM,5%,0.25W	01121	CB2225
A2R1331	321-0335-00		RES.,FXD,FILM:30.1K OHM,1%,0.125W	91637	CMF55116G30101F
A2R1332	321-0318-00		RES.,FXD,FILM:20K OHM,1%,0.125W	91637	MFF1816G20001F
A2R1333	315-0751-00		RES.,FXD,CMPSN:750 OHM,5%,0.25W	01121	CB7515
A2R1334	315-0103-00		RES.,FXD,CMPSN:10K OHM,5%,0.25W	01121	CB1035
A2R1351	315-0202-00		RES.,FXD,CMPSN:2K OHM,5%,0.25W	01121	CB2025
A2R1352	301-0150-00		RES.,FXD,CMPSN:15 OHM,5%,0.5W	01121	EB1505
A2R1353	301-0150-00		RES.,FXD,CMPSN:15 OHM,5%,0.5W	01121	EB1505
A2R1354	315-0222-00		RES.,FXD,CMPSN:2.2K OHM,5%,0.25W	01121	CB2225
A2R1355	315-0682-00		RES.,FXD,CMPSN:6.8K OHM,5%,0.25W	01121	CB6825
A2R1356	315-0512-00	B010185	RES.,FXD,CMPSN:5.1K OHM,5%,0.25W	01121	CB5125
A2R1357	321-0310-00		RES.,FXD,FILM:16.5K OHM,1%,0.125W	91637	MFF1816G16501F
A2R1358	321-0319-00		RES.,FXD,FILM:20.5K OHM,1%,0.125W	91637	MFF1816G20501F
A2R1359	315-0682-00		RES.,FXD,CMPSN:6.8K OHM,5%,0.25W	01121	CB6825
A2R1370	321-0363-00		RES.,FXD,FILM:59K OHM,1%,0.125W	91637	MFF1816G59001F
A2R1372	321-0299-00		RES.,FXD,FILM:12.7K OHM,1%,0.125W	91637	MFF1816G12701F
A2R1374	315-0103-00		RES.,FXD,CMPSN:10K OHM,5%,0.25W	01121	CB1035
A2R1376	315-0203-00		RES.,FXD,CMPSN:20K OHM,5%,0.25W	01121	CB2035
A2R1378	315-0202-00		RES.,FXD,CMPSN:2K OHM,5%,0.25W	01121	CB2025
A2R1400	315-0111-00		RES.,FXD,CMPSN:110 OHM,5%,0.25W	01121	CB1115
A2R1402	315-0111-00		RES.,FXD,CMPSN:110 OHM,5%,0.25W	01121	CB1115
A2RT1010	307-0350-00		RES.,THERMAL:7.5 OHM,10%,3.9%/DEG C	15454	75DJ7R5R0220SS
A2RT1016	307-0746-00		RES.,THERMAL:5 OHM,10%,7A/DEG C	15454	SG-6
A2S350	260-1849-00		SWITCH,PUSH:DPDT,4A,250VAC,W/BRKT	31918	NE15/F2U103EE
A2T1229	120-1401-00		XFMR,TRIG:	54937	ORD BY DESCR

Replaceable Electrical Parts—2445 Service

Component No.	Tektronix Part No.	Serial/Model No. Eff Dscont	Name & Description	Mfr Code	Mfr Part Number
A2TP201	131-0608-00		TERMINAL,PIN:0.365 L X 0.025 PH BRZ GOLD	22526	47357
A2U1260	156-1161-00		MICROCIRCUIT,LI:VOLTAGE REGULATOR	27014	LM317T
A2U1270	156-0495-02		MICROCIRCUIT,LI:QUAD OPNL AMPL,SELECTED	01295	LM324J4
A2U1281	156-0158-07		MICROCIRCUIT,LI:DUAL OPNL AMPL,SCREENED	01295	MC1458JG4
A2U1290	156-1173-00		MICROCIRCUIT,LI:VOLTAGE REFERENCE	04713	MC1403UDS
A2U1300	156-0495-02		MICROCIRCUIT,LI:QUAD OPNL AMPL,SELECTED	01295	LM324J4
A2U1330	156-0872-00		MICROCIRCUIT,LI:VOLTAGE REGULATOR	04713	MC7912C
A2U1371	156-0495-02		MICROCIRCUIT,LI:QUAD OPNL AMPL,SELECTED	01295	LM324J4
A2VR1293	152-0055-00		SEMICOND DEVICE:ZENER,0.4W,11V,5%	04713	SZG35009K1
A2W1226	131-0566-00		BUS CONDUCTOR:DUMMY RES,2.375,22 AWG	57668	JWW-0200E0
A2W1287	131-0566-00		BUS CONDUCTOR:DUMMY RES,2.375,22 AWG	57668	JWW-0200E0

Replaceable Electrical Parts—2445 Service

Component No.	Tektronix Part No.	Serial/Model No. Eff	Dscont	Name & Description	Mfr Code	Mfr Part Number
A3	-----			CKT BOARD ASSY:INVERTER		
A3	-----			(AVAILABLE AT 672-1037-01 LEVEL ONLY)		
A3C1020	285-1192-00			CAP.,FXD,PPR DI:0.0022UF,20%,250VAC	000FG	PME271Y422
A3C1021	290-0971-00			CAP.,FXD,ELCTLT:290UF,+50-10%,200V	90201	TCG291T200N
A3C1022	290-0971-00			CAP.,FXD,ELCTLT:290UF,+50-10%,200V	90201	TCG291T200N
A3C1023	281-0773-00			CAP.,FXD,CER DI:0.01UF,10%,100V	04222	MA201C103KAA
A3C1025	290-0942-00			CAP.,FXD,ELCTLT:100UF,+100-10%,25V	56289	672D107H025CG2C
A3C1032	281-0812-00			CAP.,FXD,CER DI:1000PF,10%,100V	04222	MA101C102KAA
A3C1033	281-0772-00			CAP.,FXD,CER DI:0.0047UF,10%,100V	04222	GC701C472K
A3C1034	290-0524-00	B010100	B013199	CAP.,FXD,ELCTLT:4.7UF,20%,10V	90201	TDC475M010EL
A3C1034	290-0524-01	B013200		CAP.,FXD,ELCTLT:4.7UF,20%,10V	T0875	202L1002-475MN
A3C1035	281-0772-00			CAP.,FXD,CER DI:0.0047UF,10%,100V	04222	GC701C472K
A3C1040	281-0773-00			CAP.,FXD,CER DI:0.01UF,10%,100V	04222	MA201C103KAA
A3C1048	281-0826-00			CAP.,FXD,CER DI:2200PF,5%,100V	12969	CGB222KEX
A3C1050	285-1254-00			CAP.,FXD,PLSTC:0.22UF,10%,400WVDC	84411	X363UW-224104
A3C1051	285-1192-00			CAP.,FXD,PPR DI:0.0022UF,20%,250VAC	000FG	PME271Y422
A3C1052	285-1196-00			CAP.,FXD,PAPER:0.01UF,20%,250V	80009	285-1196-00
A3C1062	281-0850-00			CAP.,FXD,CER DI:820PF,5%,50VDC	96733	R3149
A3C1065	285-1190-00			CAP.,FXD,MTLZD:0.056UF,5%,250V	55112	160.056 J 250C
A3C1066	290-0782-00	B010100	B013199	CAP.,FXD,ELCTLT:4.7UF,+75-10%,35V	55680	ULA1V4R7TEA
A3C1066	290-0782-01	B013200		CAP.,FXD,ELCTLT:4.7UF,20%,35VDC	55680	ULA1V4R7TEA1TD
A3C1067	281-0850-00			CAP.,FXD,CER DI:820PF,5%,50VDC	96733	R3149
A3C1071	281-0772-00			CAP.,FXD,CER DI:0.0047UF,10%,100V	04222	GC701C472K
A3C1072	290-0806-00			CAP.,FXD,ELCTLT:3.3UF,+75-10%,350VDC	55680	UHU2V3RTEA
A3C1075	283-0421-00			CAP.,FXD,CER DI:0.1UF,+80-20%,50V	04222	DG015E104Z
A3C1101	290-0942-00			CAP.,FXD,ELCTLT:100UF,+100-10%,25V	56289	672D107H025CG2C
A3C1102	290-0942-00			CAP.,FXD,ELCTLT:100UF,+100-10%,25V	56289	672D107H025CG2C
A3C1110	290-0800-00			CAP.,FXD,ELCTLT:250UF,+100-10%,20V	56289	672D257H0200M5C
A3C1111	290-0800-00			CAP.,FXD,ELCTLT:250UF,+100-10%,20V	56289	672D257H0200M5C
A3C1112	290-0782-00	B010100	B013199	CAP.,FXD,ELCTLT:4.7UF,+75-10%,35V	55680	ULA1V4R7TEA
A3C1112	290-0782-01	B013200		CAP.,FXD,ELCTLT:4.7UF,20%,35VDC	55680	ULA1V4R7TEA1TD
A3C1113	290-0798-00			CAP.,FXD,ELCTLT:180UF,+100-10%,40V	56289	672D187H04ODM5C
A3C1114	290-0800-00			CAP.,FXD,ELCTLT:250UF,+100-10%,20V	56289	672D257H0200M5C
A3C1115	290-0800-00			CAP.,FXD,ELCTLT:250UF,+100-10%,20V	56289	672D257H0200M5C
A3C1116	290-0798-00			CAP.,FXD,ELCTLT:180UF,+100-10%,40V	56289	672D187H04ODM5C
A3C1120	290-0939-00			CAP.,FXD,ELCTLT:10UF,+100-10%,100V	56289	672D106H100CG2C
A3C1130	290-0939-00			CAP.,FXD,ELCTLT:10UF,+100-10%,100V	56289	672D106H100CG2C
A3C1132	290-0880-00			CAP.,FXD,ELCTLT:10UF,+50-10%,160V	55680	UHU2C100TEA
A3CR1022	152-0333-00			SEMICONV DEVICE:SILICON,55V,200MA	07263	FDH-6012
A3CR1023	152-0141-02			SEMICONV DEVICE:SILICON,30V,150MA	01295	1N4152R
A3CR1028	152-0141-02			SEMICONV DEVICE:SILICON,30V,150MA	01295	1N4152R
A3CR1030	152-0141-02			SEMICONV DEVICE:SILICON,30V,150MA	01295	1N4152R
A3CR1034	152-0141-02			SEMICONV DEVICE:SILICON,30V,150MA	01295	1N4152R
A3CR1035	152-0141-02			SEMICONV DEVICE:SILICON,30V,150MA	01295	1N4152R
A3CR1040	152-0075-00			SEMICONV DEVICE:SW,GE,22V,40MA	14433	G866
A3CR1050	152-0661-00			SEMICONV DEVICE:RECT,SI,600V,3A,FAST	04713	MR856
A3CR1060	152-0040-00			SEMICONV DEVICE:SILICON,600V,1A	15238	LG109
A3CR1062	152-0333-00			SEMICONV DEVICE:SILICON,55V,200MA	07263	FDH-6012
A3CR1063	152-0333-00			SEMICONV DEVICE:SILICON,55V,200MA	07263	FDH-6012
A3CR1064	152-0333-00			SEMICONV DEVICE:SILICON,55V,200MA	07263	FDH-6012
A3CR1065	152-0333-00			SEMICONV DEVICE:SILICON,55V,200MA	07263	FDH-6012
A3CR1070	152-0040-00			SEMICONV DEVICE:SILICON,600V,1A	15238	LG109
A3CR1072	152-0066-00			SEMICONV DEVICE:SILICON,400V,750MA	14433	LG4016
A3CR1101	152-0400-00			SEMICONV DEVICE:SILICON,400V,1A	80009	152-0400-00

Replaceable Electrical Parts—2445 Service

Component No.	Tektronix Part No.	Serial/Model No. Eff	Dscont	Name & Description	Mfr Code	Mfr Part Number
A3CR1102	152-0400-00			SEMICONV DEVICE:SILICON,400V,1A	80009	152-0400-00
A3CR1103	152-0400-00			SEMICONV DEVICE:SILICON,400V,1A	80009	152-0400-00
A3CR1104	152-0400-00			SEMICONV DEVICE:SILICON,400V,1A	80009	152-0400-00
A3CR1105	152-0400-00			SEMICONV DEVICE:SILICON,400V,1A	80009	152-0400-00
A3CR1106	152-0400-00			SEMICONV DEVICE:SILICON,400V,1A	80009	152-0400-00
A3CR1110	152-0794-00			SEMICONV DEVICE:RECT,SI,10A,30V	81483	95-4269
A3CR1113	152-0633-00			SEMICONV DEVICE:RECT,SI,30V,3A	04713	1N5821
A3CR1114	152-0633-00			SEMICONV DEVICE:RECT,SI,30V,3A	04713	1N5821
A3CR1115	152-0633-00			SEMICONV DEVICE:RECT,SI,30V,3A	04713	1N5821
A3CR1116	152-0633-00			SEMICONV DEVICE:RECT,SI,30V,3A	04713	1N5821
A3CR1121	152-0400-00			SEMICONV DEVICE:SILICON,400V,1A	80009	152-0400-00
A3CR1122	152-0400-00			SEMICONV DEVICE:SILICON,400V,1A	80009	152-0400-00
A3CR1123	152-0400-00			SEMICONV DEVICE:SILICON,400V,1A	80009	152-0400-00
A3CR1124	152-0400-00			SEMICONV DEVICE:SILICON,400V,1A	80009	152-0400-00
A3CR1131	152-0400-00			SEMICONV DEVICE:SILICON,400V,1A	80009	152-0400-00
A3CR1132	152-0400-00			SEMICONV DEVICE:SILICON,400V,1A	80009	152-0400-00
A3F1101	159-0059-00			FUSE,WIRE LEAD:5A,FAST-BLOW	000HX	SPI-5A
A3F1102	159-0059-00			FUSE,WIRE LEAD:5A,FAST-BLOW	000HX	SPI-5A
A3J303	131-2926-00	B020000		CONN,RCPT,ELEC:CKT BD,1X2,02 SPACING	27264	10-10-1024
A3L1110	108-0554-00			COIL,RF:5UH	80009	108-0554-00
A3L1113	108-1144-00			COIL,RF:FIXED,27UH	34479	RL1284
A3L1114	108-1144-00			COIL,RF:FIXED,27UH	34479	RL1284
A3L1115	108-1144-00			COIL,RF:FIXED,27UH	34479	RL1284
A3L1116	108-1144-00			COIL,RF:FIXED,27UH	34479	RL1284
A3Q1021	151-0301-00			TRANSISTOR:SILICON,PNP	27014	2N2907A
A3Q1022	151-0192-00			TRANSISTOR:SILICON,NPN,SEL FROM MPS652	04713	SPS8801
A3Q1029	151-0254-00			TRANSISTOR:SILICON,NPN	03508	X38L3118
A3Q1030	151-0301-00			TRANSISTOR:SILICON,PNP	27014	2N2907A
A3Q1040	151-0302-00			TRANSISTOR:SILICON,NPN	07263	S038487
A3Q1050	151-1152-00			TRANSISTOR:MOSFE,N-CHANNEL,SI,TO-220	04713	STP3002
A3Q1060	151-1152-00			TRANSISTOR:MOSFE,N-CHANNEL,SI,TO-220	04713	STP3002
A3Q1062	151-0302-00			TRANSISTOR:SILICON,NPN	07263	S038487
A3Q1070	151-1152-00			TRANSISTOR:MOSFE,N-CHANNEL,SI,TO-220	04713	STP3002
A3R1017	315-0103-00	B010100	B013199	RES.,FXD,CMPSN:10K OHM,5%,0.25W	01121	CB1035
A3R1018	315-0394-00			RES.,FXD,CMPSN:390K OHM,5%,0.25W	01121	CB3945
A3R1019	315-0394-00			RES.,FXD,CMPSN:390K OHM,5%,0.25W	01121	CB3945
A3R1020	301-0274-00			RES.,FXD,CMPSN:270K OHM,5%,0.5W	01121	EB2745
A3R1021	315-0103-00	B010100	B013199	RES.,FXD,CMPSN:10K OHM,5%,0.25W	01121	CB1035
A3R1022	315-0104-00			RES.,FXD,CMPSN:100K OHM,5%,0.25W	01121	CB1045
A3R1023	315-0122-00			RES.,FXD,CMPSN:1.2K OHM,5%,0.25W	01121	CB1225
A3R1024	315-0473-00			RES.,FXD,CMPSN:47K OHM,5%,0.25W	01121	CB4735
A3R1025	315-0302-00			RES.,FXD,CMPSN:3K OHM,5%,0.25W	01121	CB3025
A3R1027	321-0431-00			RES.,FXD,FILM:301K OHM,1%,0.125W	91637	MFF1816G30102F
A3R1028	321-0481-00			RES.,FXD,FILM:1M OHM,1%,0.125W	91637	CMF55116G10003F
A3R1029	315-0122-00			RES.,FXD,CMPSN:1.2K OHM,5%,0.25W	01121	CB1225
A3R1030	315-0102-00			RES.,FXD,CMPSN:1K OHM,5%,0.25W	01121	CB1025
A3R1031	315-0334-00			RES.,FXD,CMPSN:330K OHM,5%,0.25W	01121	CB3345
A3R1032	321-0335-00			RES.,FXD,FILM:30.1K OHM,1%,0.125W	91637	CMF55116G30101F
A3R1033	315-0104-00			RES.,FXD,CMPSN:100K OHM,5%,0.25W	01121	CB1045
A3R1034	315-0102-00			RES.,FXD,CMPSN:1K OHM,5%,0.25W	01121	CB1025

Replaceable Electrical Parts—2445 Service

Component No.	Tektronix Part No.	Serial/Model No. Eff	Dscont	Name & Description	Mfr Code	Mfr Part Number
A3R1035	315-0103-00			RES.,FXD,CMPSN:10K OHM,5%,0.25W	01121	CB1035
A3R1036	315-0103-00			RES.,FXD,CMPSN:10K OHM,5%,0.25W	01121	CB1035
A3R1037	315-0562-00			RES.,FXD,CMPSN:5.6K OHM,5%,0.25W	01121	CB5625
A3R1040	315-0103-00			RES.,FXD,CMPSN:10K OHM,5%,0.25W	01121	CB1035
A3R1041	315-0471-00			RES.,FXD,CMPSN:470 OHM,5%,0.25W	01121	CB4715
A3R1042	315-0102-00			RES.,FXD,CMPSN:1K OHM,5%,0.25W	01121	CB1025
A3R1044	315-0273-00			RES.,FXD,CMPSN:27K OHM,5%,0.25W	01121	CB2735
A3R1045	321-0289-00			RES.,FXD,FILM:10K OHM,1%,0.125W	91637	MFF1816G10001F
A3R1046	321-0422-00			RES.,FXD,FILM:243K OHM,1%,0.125W	91637	MFF1816G24302F
A3R1050	308-0843-00			RES.,FXD WW:0.2 OHM,5%,1.0W	91637	RS1AR2000JT/R
A3R1052	315-0470-00			RES.,FXD,CMPSN:47 OHM,5%,0.25W	01121	CB4705
A3R1060	315-0470-00			RES.,FXD,CMPSN:47 OHM,5%,0.25W	01121	CB4705
A3R1061	315-0202-00			RES.,FXD,CMPSN:2K OHM,5%,0.25W	01121	CB2025
A3R1062	315-0682-00			RES.,FXD,CMPSN:6.8K OHM,5%,0.25W	01121	CB6825
A3R1063	315-0202-00			RES.,FXD,CMPSN:2K OHM,5%,0.25W	01121	CB2025
A3R1064	315-0202-00			RES.,FXD,CMPSN:2K OHM,5%,0.25W	01121	CB2025
A3R1065	315-0124-00			RES.,FXD,CMPSN:120K OHM,5%,0.25W	01121	CB1245
A3R1066	315-0202-00			RES.,FXD,CMPSN:2K OHM,5%,0.25W	01121	CB2025
A3R1067	315-0682-00			RES.,FXD,CMPSN:6.8K OHM,5%,0.25W	01121	CB6825
A3R1068	315-0202-00			RES.,FXD,CMPSN:2K OHM,5%,0.25W	01121	CB2025
A3R1069	315-0104-00			RES.,FXD,CMPSN:100K OHM,5%,0.25W	01121	CB1045
A3R1070	315-0470-00			RES.,FXD,CMPSN:47 OHM,5%,0.25W	01121	CB4705
A3R1071	315-0431-00			RES.,FXD,CMPSN:430 OHM,5%,0.25W	01121	CB4315
A3R1072	315-0203-00			RES.,FXD,CMPSN:20K OHM,5%,0.25W	01121	CB2035
A3R1075	315-0472-00			RES.,FXD,CMPSN:4.7K OHM,5%,0.25W	01121	CB4725
A3R1101	307-0103-00	B010100	B019999	RES.,FXD,CMPSN:2.7 OHM,5%,0.25W	01121	CB27G5
A3R1102	307-0103-00	B010100	B019999	RES.,FXD,CMPSN:2.7 OHM,5%,0.25W	01121	CB27G5
A3R1129	315-0474-00			RES.,FXD,CMPSN:470K OHM,5%,0.25W	01121	CB4745
A3RL1060	108-0329-00			COIL,RF:2.5UH	80009	108-0329-00
A3T1020	120-1449-00	B010100	B013199	XFMR,COM MODE:	02113	P104
A3T1020	120-1244-00	B013200		XFMR,RF:COMMON MODE,13MN,0.5A	20462	4096
A3T1050	120-1417-00			XFMR,RF:POWER HIGH FREQUENCY	54937	500-2311
A3T1060	120-1437-00			XFMR,PWR,STPDN:	02113	C1310
A3U1029	156-0885-00			MICROCIRCUIT,LI:OPTOELECTRONIC ISOLATOR	04713	S0C123A
A3U1030	156-1627-00			MICROCIRCUIT,LI:POWER WIDTH MODULATED CONT	01295	TL594CN
A3U1040	156-0885-00			MICROCIRCUIT,LI:OPTOELECTRONIC ISOLATOR	04713	S0C123A
A3U1062	156-0411-00			MICROCIRCUIT,LI:QUAD-COMP,SGL SUPPLY	27014	LM339N
A3U1064	156-0366-02			MICROCIRCUIT,DI:DUAL D FLIP-FLOP,CHK	80009	156-0366-02
A3U1066	156-0328-00			MICROCIRCUIT,DI:DUAL CLOCK DRIVER	27014	DS0026C
A3VR1020	152-0166-00			SEMICONV DEVICE:ZENER,0.4W,6.2V,5%	04713	SZ11738RL
A3VR1062	152-0168-00			SEMICONV DEVICE:ZENER,0.4W,12V,5%	04713	SZG35009K4
A3W1021	131-0566-00			BUS CONDUCTOR:DUMMY RES,2.375,22 AWG	57668	JWW-0200E0
A3W1022	131-0566-00			BUS CONDUCTOR:DUMMY RES,2.375,22 AWG	57668	JWW-0200E0
A3W1050	131-0566-00			BUS CONDUCTOR:DUMMY RES,2.375,22 AWG	57668	JWW-0200E0
A3W1060	131-0566-00			BUS CONDUCTOR:DUMMY RES,2.375,22 AWG	57668	JWW-0200E0
A3W1101	131-0566-00	B020000		BUS CONDUCTOR:DUMMY RES,2.375,22 AWG	57668	JWW-0200E0
A3W1102	131-0566-00	B020000		BUS CONDUCTOR:DUMMY RES,2.375,22 AWG	57668	JWW-0200E0

Replaceable Electrical Parts—2445 Service

Component No.	Tektronix	Serial/Model No.		Name & Description	Mfr	Mfr Part Number
	Part No.	Eff	Dscont		Code	
A4	670-7278-00			CKT BOARD ASSY:BUS READOUT	80009	670-7278-00
A4C2830	281-0775-00			CAP.,FXD,CER DI:0.1UF,20%,50V	04222	MA205E104MAA
A4C2835	281-0775-00			CAP.,FXD,CER DI:0.1UF,20%,50V	04222	MA205E104MAA
A4C2851	281-0775-00			CAP.,FXD,CER DI:0.1UF,20%,50V	04222	MA205E104MAA
A4C2855	281-0775-00			CAP.,FXD,CER DI:0.1UF,20%,50V	04222	MA205E104MAA
A4C2860	281-0775-00			CAP.,FXD,CER DI:0.1UF,20%,50V	04222	MA205E104MAA
A4C2885	281-0775-00			CAP.,FXD,CER DI:0.1UF,20%,50V	04222	MA205E104MAA
A4C2901	281-0775-00			CAP.,FXD,CER DI:0.1UF,20%,50V	04222	MA205E104MAA
A4C2911	281-0773-00			CAP.,FXD,CER DI:0.01UF,10%,100V	04222	MA201C103KAA
A4C2913	281-0775-00			CAP.,FXD,CER DI:0.1UF,20%,50V	04222	MA205E104MAA
A4C2926	281-0775-00			CAP.,FXD,CER DI:0.1UF,20%,50V	04222	MA205E104MAA
A4C2940	281-0775-00			CAP.,FXD,CER DI:0.1UF,20%,50V	04222	MA205E104MAA
A4C2950	281-0775-00			CAP.,FXD,CER DI:0.1UF,20%,50V	04222	MA205E104MAA
A4C2960	281-0775-00			CAP.,FXD,CER DI:0.1UF,20%,50V	04222	MA205E104MAA
A4C2970	281-0775-00			CAP.,FXD,CER DI:0.1UF,20%,50V	04222	MA205E104MAA
A4C2980	281-0775-00			CAP.,FXD,CER DI:0.1UF,20%,50V	04222	MA205E104MAA
A4C2990	281-0775-00			CAP.,FXD,CER DI:0.1UF,20%,50V	04222	MA205E104MAA
A4R2805	315-0472-00			RES.,FXD,CMPSN:4.7K OHM,5%,0.25W	01121	CB4725
A4R2830	315-0101-00			RES.,FXD,CMPSN:100 OHM <5%,0.25W	01121	CB1015
A4R2841	315-0103-00			RES.,FXD,CMPSN:10K OHM,5%,0.25W	01121	CB1035
A4R2842	315-0103-00			RES.,FXD,CMPSN:10K OHM,5%,0.25W	01121	CB1035
A4R2843	315-0472-00			RES.,FXD,CMPSN:4.7K OHM,5%,0.25W	01121	CB4725
A4R2844	315-0472-00			RES.,FXD,CMPSN:4.7K OHM,5%,0.25W	01121	CB4725
A4R2850	315-0472-00			RES.,FXD,CMPSN:4.7K OHM,5%,0.25W	01121	CB4725
A4R2901	315-0103-00			RES.,FXD,CMPSN:10K OHM,5%,0.25W	01121	CB1035
A4R2902	315-0102-00			RES.,FXD,CMPSN:1K OHM,5%,0.25W	01121	CB1025
A4R2903	321-1296-03			RES.,FXD,FILM:12K OHM,0.25%,0.125W	91637	MFF1816D12001C
A4R2905	321-0816-03			RES.,FXD,FILM:5K OHM,0.25%,0.125W	91637	MFF1816D50000C
A4R2910	321-0685-00			RES.,FXD,FILM:30K OHM,0.5%,0.125W	91637	MFF1816D30001D
A4R2911	321-0685-00			RES.,FXD,FILM:30K OHM,0.5%,0.125W	91637	MFF1816D30001D
A4R2912	315-0102-00			RES.,FXD,CMPSN:1K OHM,5%,0.25W	01121	CB1025
A4R2913	321-0198-00			RES.,FXD,FILM:1.13K OHM,1%,0.125W	91637	MFF1816G11300F
A4R2914	321-0306-00			RES.,FXD,FILM:15K OHM,1%,0.125W	91637	MFF1816G15001F
A4R2915	315-0202-00			RES.,FXD,CMPSN:2K OHM,5%,0.25W	01121	CB2025
A4R2920	315-0334-00			RES.,FXD,CMPSN:330K OHM,5%,0.25W	01121	CB3345
A4R2921	321-0724-03			RES.,FXD,FILM:13.6K OHM,0.25W,0.125W	24546	NC55C1362C
A4R2922	321-0756-00			RES.,FXD,FILM:50K OHM,1%,0.125W	24546	NA55D5002F
A4R2923	321-0385-00			RES.,FXD,FILM:100K OHM,1%,0.125W	91637	MFF1816G10002F
A4R2924	321-0414-00			RES.,FXD,FILM:200K OHM,1%,0.125W	91637	MFF1816G20002F
A4R2925	321-0235-02			RES.,FXD,FILM:2.74K OHM,0.5%,0.125W	91637	MFF1816G2741F
A4R2926	321-0225-01			RES.,FXD,FLIM:2.15K OHM,5%,0.125W	80009	321-0255-01
A4R2927	315-0203-00			RES.,FXD,CMPSN:20K OHM,5%,0.25W	01121	CB2035
A4R2928	315-0472-00			RES.,FXD,CMPSN:4.7K OHM,5%,0.25W	01121	CB4725
A4R2929	315-0472-00			RES.,FXD,CMPSN:4.7K OHM,5%,0.25W	01121	CB4725
A4R2940	315-0102-00			RES.,FXD,CMPSN:1K OHM,5%,0.25W	01121	CB1025
A4R2945	315-0471-00			RES.,FXD,CMPSN:470 OHM,5%,0.25W	01121	CB4715
A4R2975	315-0472-00			RES.,FXD,CMPSN:4.7K OHM,5%,0.25W	01121	CB4725
A4R2985	315-0102-00			RES.,FXD,CMPSN:1K OHM,5%,0.25W	01121	CB1025
A4U2800	156-0514-01			MICROCIRCUIT,DI:DIFF 4-CHANNEL MUX,SEL	80009	156-0514-01
A4U2805	156-0514-01			MICROCIRCUIT,DI:DIFF 4-CHANNEL MUX,SEL	80009	156-0514-01
A4U2810	156-0382-02			MICROCIRCUIT,DI:QUAD 2-INP NAND GATE	01295	SN74LS00
A4U2820	156-1191-01			MICROCIRCUIT,LI:DUAL BI-FET OP-AMP,8 DIP	01295	TL072ACP3

Replaceable Electrical Parts—2445 Service

Component No.	Tektronix Part No.	Serial/Model No. Eff	Dscont	Name & Description	Mfr Code	Mfr Part Number
A4U2830	156-1172-01			MICROCIRCUIT,DI:DUAL 4 BIT CNTR	01295	SN74LS393
A4U2835	156-0479-02			MICROCIRCUIT,DI:QUAD 2-INP OR GATE	01295	SN74LS32NP3
A4U2850	156-0388-03			MICROCIRCUIT,DI:DUAL D FLIP-FLOP	07263	74LS74A
A4U2855	156-0383-02			MICROCIRCUIT,DI:QUAD 2-INP NOR GATE	01295	SN74LS02
A4U2860	156-0975-02			MICROCIRCUIT,DI:UNIV SHIFT/STORAGE RGTR	01295	SN74LS299N3/J4
A4U2865	156-0796-01			MICROCIRCUIT,DI:8 STG SHF & STORE BUS RGTR	80009	156-0796-01
A4U2870	156-1172-01			MICROCIRCUIT,DI:DUAL 4 BIT CNTR	01295	SN74LS393
A4U2880	156-0388-03			MICROCIRCUIT,DI:DUAL D FLIP-FLOP	07263	74LS74A
A4U2885	156-0386-02			MICROCIRCUIT,DI:TRIPLE 3-INP NAND GATE	27014	DM74LS10N
A4U2890	156-0382-02			MICROCIRCUIT,DI:QUAD 2-INP NAND GATE	01295	SN74LS00
A4U2900	156-0386-02			MICROCIRCUIT,DI:TRIPLE 3-INP NAND GATE	27014	DM74LS10N
A4U2905	156-0982-03			MICROCIRCUIT,DI:OCTAL-D-EDGE FF,SCRN	01295	SN74LS374 N3
A4U2910	156-1555-00			MICROCIRCUIT,LI:D/A CONVERTER	34335	AM6080PC
A4U2920	156-0716-01			MICROCIRCUIT,DI:128 X 8 STATIC RAM,SCRN	80009	156-0716-01
A4U2930	160-1631-00	B010100	B01999	MICROCIRCUIT,DI:4096 X 8 EPROM	80009	160-1631-00
A4U2930	160-1631-02	B020000		MICROCIRCUIT,DI:4096 X 8 EPROM,PRGM	80009	160-1631-02
A4U2935	156-0956-02			MICROCIRCUIT,DI:OCTAL BFR W/3 STATE OUT	01295	SN74LS244NP3
A4U2940	156-1172-01			MICROCIRCUIT,DI:DUAL 4 BIT CNTR	01295	SN74LS393
A4U2950	156-0388-03			MICROCIRCUIT,DI:DUAL D FLIP-FLOP	07263	74LS74A
A4U2960	156-0796-01			MICROCIRCUIT,DI:8 STG SHF & STORE BUS RGTR	80009	156-0796-01
A4U2965	156-0382-02			MICROCIRCUIT,DI:QUAD 2-INP NAND GATE	01295	SN74LS00
A4U2970	156-0480-02			MICROCIRCUIT,DI:QUAD 2 INP & GATE	01295	SN74LS08NP3
A4U2980	156-0382-02			MICROCIRCUIT,DI:QUAD 2-INP NAND GATE	01295	SN74LS00
A4U2985	156-0768-01			MICROCIRCUIT,DI:BIDIRECT UNIV SR,SCREENED	01295	SN74LS194A9NP3 O
A4U2990	156-0381-02			MICROCIRCUIT,DI:QUAD 2-INP EXCL OR GATE	01295	SN74LS86
A4U2995	156-0651-02			MICROCIRCUIT,DI:8 BIT PRL-OUT SER SHF RGTR	01295	SN74LS164(NP3 OR
A4VR2805	152-0217-00			SEMICONV DEVICE:ZENER,0.4W,8.2V,5%	04713	SZG20
A4VR2925	152-0662-00			SEMICONV DEVICE:ZENER,0.4W,5V,1%	04713	SZG195
A4W2851	131-0566-00			BUS CONDUCTOR:DUMMY RES,2.375,22 AWG	57668	JWW-0200E0
A4W2913	131-0566-00			BUS CONDUCTOR:DUMMY RES,2.375,22 AWG	57668	JWW-0200E0

Replaceable Electrical Parts—2445 Service

Component No.	Tektronix Part No.	Serial/Model No. Eff	Dscont	Name & Description	Mfr Code	Mfr Part Number
A5	670-7279-00	B010100	B01319	CKT BOARD ASSY:DIGITAL CONTROL	80009	670-7279-00
A5	670-7279-04	B013200		CKT BOARD ASSY:DIGITAL CONTROL	80009	670-7279-04
A5C2041	281-0775-00			CAP.,FXD,CER DI:0.1UF,20%,50V	04222	MA205E104MAA
A5C2188	281-0775-00			CAP.,FXD,CER DI:0.1UF,20%,50V	04222	MA205E104MAA
A5C2203	281-0775-00			CAP.,FXD,CER DI:0.1UF,20%,50V	04222	MA205E104MAA
A5C2217	281-0775-00			CAP.,FXD,CER DI:0.1UF,20%,50V	04222	MA205E104MAA
A5C2218	281-0775-00			CAP.,FXD,CER DI:0.1UF,20%,50V	04222	MA205E104MAA
A5C2221	281-0775-00			CAP.,FXD,CER DI:0.1UF,20%,50V	04222	MA205E104MAA
A5C2222	281-0814-00			CAP.,FXD,CER DI:100PF,10%,100V	04222	GC101A101K
A5C2223	290-0943-00			CAP.,FXD,ELCTL:47UF,+50-10%,25V	55680	ULB1E470TECANA
A5C2224	290-0943-00			CAP.,FXD,ELCTL:47UF,+50-10%,25V	55680	ULB1E470TECANA
A5C2240	281-0775-00			CAP.,FXD,CER DI:0.1UF,20%,50V	04222	MA205E104MAA
A5C2318	281-0791-00			CAP.,FXD,CER DI:270PF,10%,100V	04222	MA101A271KAA
A5C2326	281-0775-00			CAP.,FXD,CER DI:0.1UF,20%,50V	04222	MA205E104MAA
A5C2327	281-0775-00			CAP.,FXD,CER DI:0.1UF,20%,50V	04222	MA205E104MAA
A5C2328	281-0775-00			CAP.,FXD,CER DI:0.1UF,20%,50V	04222	MA205E104MAA
A5C2329	281-0775-00			CAP.,FXD,CER DI:0.1UF,20%,50V	04222	MA205E104MAA
A5C2330	285-1187-00			CAP.,FXD,MTLZD:0.47UF,10%,100V	55112	160.47 K 100F
A5C2346	281-0775-00			CAP.,FXD,CER DI:0.1UF,20%,50V	04222	MA205E104MAA
A5C2354	290-0943-00			CAP.,FXD,ELCTL:47UF,+50-10%,25V	55680	ULB1E470TECANA
A5C2440	281-0775-00			CAP.,FXD,CER DI:0.1UF,20%,50V	04222	MA205E104MAA
A5C2441	285-1187-00			CAP.,FXD,MTLZD:0.47UF,10%,100V	55112	160.47 K 100F
A5C2443	281-0775-00			CAP.,FXD,CER DI:0.1UF,20%,50V	04222	MA205E104MAA
A5C2475	281-0775-00			CAP.,FXD,CER DI:0.1UF,20%,50V	04222	MA205E104MAA
A5C2485	281-0775-00			CAP.,FXD,CER DI:0.1UF,20%,50V	04222	MA205E104MAA
A5C2486	281-0775-00			CAP.,FXD,CER DI:0.1UF,20%,50V	04222	MA205E104MAA
A5C2524	281-0775-00			CAP.,FXD,CER DI:0.1UF,20%,50V	04222	MA205E104MAA
A5C2527	281-0775-00			CAP.,FXD,CER DI:0.1UF,20%,50V	04222	MA205E104MAA
A5C2530	283-0423-00			CAP.,FXD,CER DI:0.22UF,+80-20%,50V	04222	DG015E224Z
A5C2536	281-0775-00			CAP.,FXD,CER DI:0.1UF,20%,50V	04222	MA205E104MAA
A5C2540	283-0423-00			CAP.,FXD,CER DI:0.22UF,+80-20%,50V	04222	DG015E224Z
A5C2542	283-0423-00			CAP.,FXD,CER DI:0.22UF,+80-20%,50V	04222	DG015E224Z
A5C2550	281-0775-00			CAP.,FXD,CER DI:0.1UF,20%,50V	04222	MA205E104MAA
A5C2565	281-0816-00			CAP.,FXD,CER DI:82PF,5%,100V	96733	R3247
A5C2566	281-0819-00			CAP.,FXD,CER DI:33PF,5%,50V	72982	8035BC0G330
A5C2572	281-0775-00			CAP.,FXD,CER DI:0.1UF,20%,50V	04222	MA205E104MAA
A5C2575	281-0775-00			CAP.,FXD,CER DI:0.1UF,20%,50V	04222	MA205E104MAA
A5C2586	281-0775-00			CAP.,FXD,CER DI:0.1UF,20%,50V	04222	MA205E104MAA
A5C2637	283-0423-00			CAP.,FXD,CER DI:0.22UF,+80-20%,50V	04222	DG015E224Z
A5C2638	285-1187-00			CAP.,FXD,MTLZD:0.47UF,10%,100V	55112	160.47 K 100F
A5C2640	285-1187-00			CAP.,FXD,MTLZD:0.47UF,10%,100V	55112	160.47 K 100F
A5C2642	281-0775-00			CAP.,FXD,CER DI:0.1UF,20%,50V	04222	MA205E104MAA
A5C2661	281-0775-00			CAP.,FXD,CER DI:0.1UF,20%,50V	04222	MA205E104MAA
A5C2734	281-0775-00			CAP.,FXD,CER DI:0.1UF,20%,50V	04222	MA205E104MAA
A5CR2004	152-0141-02			SEMICONV DEVICE:SILICON,30V,150MA	01295	1N4152R
A5CR2021	152-0141-02			SEMICONV DEVICE:SILICON,30V,150MA	01295	1N4152R
A5CR2122	152-0141-02			SEMICONV DEVICE:SILICON,30V,150MA	01295	1N4152R
A5CR2651	152-0141-02			SEMICONV DEVICE:SILICON,30V,150MA	01295	1N4152R
A5CR2723	152-0141-02			SEMICONV DEVICE:SILICON,30V,150MA	01295	1N4152R
A5CR2731	152-0141-02			SEMICONV DEVICE:SILICON,30V,150MA	01295	1N4152R
A5CR2733	152-0141-02			SEMICONV DEVICE:SILICON,30V,150MA	01295	1N4152R
A5CR2742	152-0141-02			SEMICONV DEVICE:SILICON,30V,150MA	01295	1N4152R
A5CR2744	152-0141-02			SEMICONV DEVICE:SILICON,30V,150MA	01295	1N4152R

Replaceable Electrical Parts—2445 Service

Component No.	Tektronix Part No.	Serial/Model No. Eff Dscont	Name & Description	Mfr Code	Mfr Part Number
A5Q2025	151-0188-00		TRANSISTOR:SILICON,PNP	04713	SPS6868
A5Q2322	151-0341-00		TRANSISTOR:SILICON,NPN	07263	S040065
A5R2012	315-0512-00		RES.,FXD,CMPSN:5.1K OHM,5%,0.25W	01121	CB5125
A5R2013	315-0103-00		RES.,FXD,CMPSN:10K OHM,5%,0.25W	01121	CB1035
A5R2014	315-0103-00		RES.,FXD,CMPSN:10K OHM,5%,0.25W	01121	CB1035
A5R2015	315-0512-00		RES.,FXD,CMPSN:5.1K OHM,5%,0.25W	01121	CB5125
A5R2016	315-0512-00		RES.,FXD,CMPSN:5.1K OHM,5%,0.25W	01121	CB5125
A5R2017	315-0103-00		RES.,FXD,CMPSN:10K OHM,5%,0.25W	01121	CB1035
A5R2018	315-0103-00		RES.,FXD,CMPSN:10K OHM,5%,0.25W	01121	CB1035
A5R2019	315-0512-00		RES.,FXD,CMPSN:5.1K OHM,5%,0.25W	01121	CB5125
A5R2020	315-0103-00		RES.,FXD,CMPSN:10K OHM,5%,0.25W	01121	CB1035
A5R2022	315-0512-00		RES.,FXD,CMPSN:5.1K OHM,5%,0.25W	01121	CB5125
A5R2023	315-0203-00		RES.,FXD,CMPSN:20K OHM,5%,0.25W	01121	CB2035
A5R2028	315-0134-00		RES.,FXD,CMPSN:130K OHM,5%,0.25W	01121	CB1345
A5R2029	315-0134-00		RES.,FXD,CMPSN:130K OHM,5%,0.25W	01121	CB1345
A5R2040	315-0103-00		RES.,FXD,CMPSN:10K OHM,5%,0.25W	01121	CB1035
A5R2103	315-0102-00		RES.,FXD,CMPSN:1K OHM,5%,0.25W	01121	CB1025
A5R2113	315-0103-00		RES.,FXD,CMPSN:10K OHM,5%,0.25W	01121	CB1035
A5R2123	315-0222-00		RES.,FXD,CMPSN:2.2K OHM,5%,0.25W	01121	CB2225
A5R2025	315-0103-00	B013200	RES.,FXD,CMPSN:10K OHM,5%,0.25W	01121	CB1035
A5R2127	311-1137-00		RES.,VAR,NONWIR:5K OHM,20%,0.50W	73138	72PX-67-0-502M
A5R2132	315-0103-00		RES.,FXD,CMPSN:10K OHM,5%,0.25W	01121	CB1035
A5R2140	315-0101-00		RES.,FXD,CMPSN:100 OHM<5%,0.25W	01121	CB1015
A5R2141	315-0101-00		RES.,FXD,CMPSN:100 OHM<5%,0.25W	01121	CB1015
A5R2142	315-0103-00		RES.,FXD,CMPSN:10K OHM,5%,0.25W	01121	CB1035
A5R2143	315-0101-00		RES.,FXD,CMPSN:100 OHM<5%,0.25W	01121	CB1015
A5R2144	315-0101-00		RES.,FXD,CMPSN:100 OHM<5%,0.25W	01121	CB1015
A5R2145	315-0101-00		RES.,FXD,CMPSN:100 OHM<5%,0.25W	01121	CB1015
A5R2162	315-0103-00		RES.,FXD,CMPSN:10K OHM,5%,0.25W	01121	CB1035
A5R2185	315-0102-00		RES.,FXD,CMPSN:1K OHM,5%,0.25W	01121	CB1025
A5R2186	315-0103-00		RES.,FXD,CMPSN:10K OHM,5%,0.25W	01121	CB1035
A5R2187	315-0104-00		RES.,FXD,CMPSN:100K OHM,5%,0.25W	01121	CB1045
A5R2224	315-0103-00		RES.,FXD,CMPSN:10K OHM,5%,0.25W	01121	CB1035
A5R2227	321-0289-02		RES.,FXD,FILM:10K OHM,0.5%,0.125W	91637	CMF55-116D10001D
A5R2228	321-0289-02		RES.,FXD,FILM:10K OHM,0.5%,0.125W	91637	CMF55-116D10001D
A5R2229	321-0431-00		RES.,FXD,FILM:301K OHM,1%,0.125W	91637	MFF1816G30102F
A5R2230	315-0103-00		RES.,FXD,CMPSN:10K OHM,5%,0.25W	01121	CB1035
A5R2241	315-0101-00		RES.,FXD,CMPSN:100 OHM<5%,0.25W	01121	CB1015
A5R2242	315-0101-00		RES.,FXD,CMPSN:100 OHM<5%,0.25W	01121	CB1015
A5R2243	315-0101-00		RES.,FXD,CMPSN:100 OHM<5%,0.25W	01121	CB1015
A5R2244	315-0101-00		RES.,FXD,CMPSN:100 OHM<5%,0.25W	01121	CB1015
A5R2245	315-0101-00		RES.,FXD,CMPSN:100 OHM<5%,0.25W	01121	CB1015
A5R2246	315-0101-00		RES.,FXD,CMPSN:100 OHM<5%,0.25W	01121	CB1015
A5R2285	315-0103-00		RES.,FXD,CMPSN:10K OHM,5%,0.25W	01121	CB1035
A5R2286	315-0104-00		RES.,FXD,CMPSN:100K OHM,5%,0.25W	01121	CB1045
A5R2287	315-0104-00		RES.,FXD,CMPSN:100K OHM,5%,0.25W	01121	CB1045
A5R2288	315-0104-00		RES.,FXD,CMPSN:100K OHM,5%,0.25W	01121	CB1045
A5R2297	315-0104-00		RES.,FXD,CMPSN:100K OHM,5%,0.25W	01121	CB1045
A5R2298	315-0104-00		RES.,FXD,CMPSN:100K OHM,5%,0.25W	01121	CB1045
A5R2299	315-0104-00		RES.,FXD,CMPSN:100K OHM,5%,0.25W	01121	CB1045
A5R2303	315-0103-00		RES.,FXD,CMPSN:10K OHM,5%,0.25W	01121	CB1035
A5R2312	315-0103-00		RES.,FXD,CMPSN:10K OHM,5%,0.25W	01121	CB1035
A5R2313	315-0103-00		RES.,FXD,CMPSN:10K OHM,5%,0.25W	01121	CB1035
A5R2314	315-0102-00		RES.,FXD,CMPSN:1K OHM,5%,0.25W	01121	CB1025

Replaceable Electrical Parts—2445 Service

Component No.	Tektronix	Serial/Model No.		Name & Description	Mfr Code	Mfr Part Number
	Part No.	Eff	Dscont			
A5R2315	315-0102-00			RES.,FXD,CMPSN:1K OHM,5%,0.25W	01121	CB1025
A5R2316	315-0102-00			RES.,FXD,CMPSN:1K OHM,5%,0.25W	01121	CB1025
A5R2317	315-0102-00			RES.,FXD,CMPSN:1K OHM,5%,0.25W	01121	CB1025
A5R2319	315-0104-00			RES.,FXD,CMPSN:100K OHM,5%,0.25W	01121	CB1045
A5R2320	315-0103-00			RES.,FXD,CMPSN:10K OHM,5%,0.25W	01121	CB1035
A5R2324	321-0177-02			RES.,FXD,FILM:681 OHM,0.5%,0.125W	91637	CMF55116D681R0D
A5R2325	321-0177-02			RES.,FXD,FILM:681 OHM,0.5%,0.125W	91637	CMF55116D681R0D
A5R2330	315-0203-00			RES.,FXD,CMPSN:20K OHM,5%,0.25W	01121	CB2035
A5R2340	315-0103-00			RES.,FXD,CMPSN:10K OHM,5%,0.25W	01121	CB1035
A5R2341	315-0103-00			RES.,FXD,CMPSN:10K OHM,5%,0.25W	01121	CB1035
A5R2342	315-0103-00			RES.,FXD,CMPSN:10K OHM,5%,0.25W	01121	CB1035
A5R2343	315-0103-00			RES.,FXD,CMPSN:10K OHM,5%,0.25W	01121	CB1035
A5R2344	315-0103-00			RES.,FXD,CMPSN:10K OHM,5%,0.25W	01121	CB1035
A5R2345	315-0103-00			RES.,FXD,CMPSN:10K OHM,5%,0.25W	01121	CB1035
A5R2444	315-0103-00			RES.,FXD,CMPSN:10K OHM,5%,0.25W	01121	CB1035
A5R2445	315-0103-00			RES.,FXD,CMPSN:10K OHM,5%,0.25W	01121	CB1035
A5R2446	315-0103-00			RES.,FXD,CMPSN:10K OHM,5%,0.25W	01121	CB1035
A5R2447	315-0103-00			RES.,FXD,CMPSN:10K OHM,5%,0.25W	01121	CB1035
A5R2448	315-0103-00			RES.,FXD,CMPSN:10K OHM,5%,0.25W	01121	CB1035
A5R2449	315-0103-00			RES.,FXD,CMPSN:10K OHM,5%,0.25W	01121	CB1035
A5R2450	315-0103-00			RES.,FXD,CMPSN:10K OHM,5%,0.25W	01121	CB1035
A5R2451	315-0103-00			RES.,FXD,CMPSN:10K OHM,5%,0.25W	01121	CB1035
A5R2452	315-0103-00			RES.,FXD,CMPSN:10K OHM,5%,0.25W	01121	CB1035
A5R2463	315-0103-00			RES.,FXD,CMPSN:10K OHM,5%,0.25W	01121	CB1035
A5R2504	315-0103-00			RES.,FXD,CMPSN:10K OHM,5%,0.25W	01121	CB1035
A5R2505	315-0103-00			RES.,FXD,CMPSN:10K OHM,5%,0.25W	01121	CB1035
A5R2506	315-0103-00			RES.,FXD,CMPSN:10K OHM,5%,0.25W	01121	CB1035
A5R2507	315-0103-00			RES.,FXD,CMPSN:10K OHM,5%,0.25W	01121	CB1035
A5R2508	315-0103-00			RES.,FXD,CMPSN:10K OHM,5%,0.25W	01121	CB1035
A5R2509	315-0103-00			RES.,FXD,CMPSN:10K OHM,5%,0.25W	01121	CB1035
A5R2510	315-0103-00			RES.,FXD,CMPSN:10K OHM,5%,0.25W	01121	CB1035
A5R2511	315-0103-00			RES.,FXD,CMPSN:10K OHM,5%,0.25W	01121	CB1035
A5R2512	315-0103-00			RES.,FXD,CMPSN:10K OHM,5%,0.25W	01121	CB1035
A5R2513	315-0103-00			RES.,FXD,CMPSN:10K OHM,5%,0.25W	01121	CB1035
A5R2514	315-0103-00			RES.,FXD,CMPSN:10K OHM,5%,0.25W	01121	CB1035
A5R2515	315-0103-00			RES.,FXD,CMPSN:10K OHM,5%,0.25W	01121	CB1035
A5R2516	315-0103-00			RES.,FXD,CMPSN:10K OHM,5%,0.25W	01121	CB1035
A5R2517	315-0103-00			RES.,FXD,CMPSN:10K OHM,5%,0.25W	01121	CB1035
A5R2518	315-0103-00			RES.,FXD,CMPSN:10K OHM,5%,0.25W	01121	CB1035
A5R2519	315-0103-00			RES.,FXD,CMPSN:10K OHM,5%,0.25W	01121	CB1035
A5R2520	315-0103-00			RES.,FXD,CMPSN:10K OHM,5%,0.25W	01121	CB1035
A5R2521	315-0103-00			RES.,FXD,CMPSN:10K OHM,5%,0.25W	01121	CB1035
A5R2522	321-0917-03			RES.,FXD,FILM:27.2K OHM,0.25%,0.125W	91637	CMF55116D27201C
A5R2525	321-0327-03			RES.,FXD,FILM:24.9K OHM,0.25%,0.125W	24546	NC55C2492C
A5R2532	321-0324-00			RES.,FXD,FILM:23.2K OHM,1%,0.125W	91637	MFF1816G23201F
A5R2534	321-0289-02			RES.,FXD,FILM:10K OHM,0.5%,0.125W	91637	CMF55-116D10001D
A5R2535	315-0683-00			RES.,FXD,CMPSN:68K OHM,5%,0.25W	01121	CB6835
A5R2539	315-0103-00			RES.,FXD,CMPSN:10K OHM,5%,0.25W	01121	CB1035
A5R2540	321-1618-02			RES.,FXD,FILM:6.5K OHM,0.5%,0.125W	91637	MFF1618D65000D
A5R2541	321-0923-02			RES.,FXD,FILM:25.1K OHM,0.5%,0.125W	24546	NC55C2512D
A5R2542	315-0203-00			RES.,FXD,CMPSN:20K OHM,5%,0.25W	01121	CB2035
A5R2543	315-0203-00			RES.,FXD,CMPSN:20K OHM,5%,0.25W	01121	CB2035
A5R2545	315-0103-00			RES.,FXD,CMPSN:10K OHM,5%,0.25W	01121	CB1035
A5R2546	315-0103-00			RES.,FXD,CMPSN:10K OHM,5%,0.25W	01121	CB1035
A5R2547	315-0103-00			RES.,FXD,CMPSN:10K OHM,5%,0.25W	01121	CB1035

Replaceable Electrical Parts—2445 Service

Component No.	Tektronix Part No.	Serial/Model No. Eff	Dscont	Name & Description	Mfr Code	Mfr Part Number
A5R2549	315-0681-00			RES.,FXD,CMPSN:680 OHM,5%,0.25W	01121	CB6815
A5R2551	315-0103-00			RES.,FXD,CMPSN:10K OHM,5%,0.25W	01121	CB1035
A5R2552	315-0102-00			RES.,FXD,CMPSN:1K OHM,5%,0.25W	01121	CB1025
A5R2553	315-0103-00			RES.,FXD,CMPSN:10K OHM,5%,0.25W	01121	CB1035
A5R2564	315-0331-00			RES.,FXD,CMPSN:330 OHM,5%,0.25W	01121	CB3315
A5R2571	315-0102-00			RES.,FXD,CMPSN:1K OHM,5%,0.25W	01121	CB1025
A5R2573	315-0102-00			RES.,FXD,CMPSN:1K OHM,5%,0.25W	01121	CB1025
A5R2608	315-0100-00			RES.,FXD,CMPSN:10 OHM,5%,0.25W	01121	CB1005
A5R2609	315-0104-00			RES.,FXD,CMPSN:100K OHM,5%,0.25W	01121	CB1045
A5R2610	315-0104-00			RES.,FXD,CMPSN:100K OHM,5%,0.25W	01121	CB1045
A5R2611	315-0104-00			RES.,FXD,CMPSN:100K OHM,5%,0.25W	01121	CB1045
A5R2612	315-0104-00			RES.,FXD,CMPSN:100K OHM,5%,0.25W	01121	CB1045
A5R2613	315-0103-00			RES.,FXD,CMPSN:10K OHM,5%,0.25W	01121	CB1035
A5R2614	315-0103-00			RES.,FXD,CMPSN:10K OHM,5%,0.25W	01121	CB1035
A5R2645	315-0103-00			RES.,FXD,CMPSN:10K OHM,5%,0.25W	01121	CB1035
A5R2646	315-0332-00			RES.,FXD,CMPSN:3.3K OHM,5%,0.25W	01121	CB3325
A5R2647	315-0682-00			RES.,FXD,CMPSN:6.8K OHM,5%,0.25W	01121	CB6825
A5R2648	315-0243-00			RES.,FXD,CMPSN:24K OHM,5%,0.25W	01121	CB2435
A5R2649	315-0273-00			RES.,FXD,CMPSN:27K OHM,5%,0.25W	01121	CB2735
A5R2650	315-0103-00			RES.,FXD,CMPSN:10K OHM,5%,0.25W	01121	CB1035
A5R2652	315-0225-00			RES.,FXD,CMPSN:2.2M OHM,5%,0.25W	01121	CB2255
A5R2662	315-0103-00			RES.,FXD,CMPSN:10K OHM,5%,0.25W	01121	CB1035
A5R2663	315-0103-00			RES.,FXD,CMPSN:10K OHM,5%,0.25W	01121	CB1035
A5R2703	315-0471-00			RES.,FXD,CMPSN:470 OHM,5%,0.25W	01121	CB4715
A5R2730	315-0103-00			RES.,FXD,CMPSN:10K OHM,5%,0.25W	01121	CB1035
A5R2731	315-0103-00			RES.,FXD,CMPSN:10K OHM,5%,0.25W	01121	CB1035
A5R2732	315-0222-00			RES.,FXD,CMPSN:2.2K OHM,5%,0.25W	01121	CB2225
A5R2734	315-0512-00			RES.,FXD,CMPSN:5.1K OHM,5%,0.25W	01121	CB5125
A5R2735	315-0103-00			RES.,FXD,CMPSN:10K OHM,5%,0.25W	01121	CB1035
A5R2741	315-0222-00			RES.,FXD,CMPSN:2.2K OHM,5%,0.25W	01121	CB2225
A5R2742	315-0512-00			RES.,FXD,CMPSN:5.1K OHM,5%,0.25W	01121	CB5125
A5R2745	315-0103-00			RES.,FXD,CMPSN:10K OHM,5%,0.25W	01121	CB1035
A5R2764	315-0102-00			RES.,FXD,CMPSN:1K OHM,5%,0.25W	01121	CB1025
A5TP503	131-0608-00			TERMINAL,PIN:0.365 L X 0.025 PH BRZ GOLD	22526	47357
A5TP504	131-0608-00			TERMINAL,PIN:0.365 L X 0.025 PH BRZ GOLD	22526	47357
A5TP505	131-0608-00			TERMINAL,PIN:0.365 L X 0.025 PH BRZ GOLD	22526	47357
A5TP506	131-0608-00			TERMINAL,PIN:0.365 L X 0.025 PH BRZ GOLD	22526	47357
A5TP507	131-0608-00			TERMINAL,PIN:0.365 L X 0.025 PH BRZ GOLD	22526	47357
A5TP509	131-0608-00			TERMINAL,PIN:0.365 L X 0.025 PH BRZ GOLD	22526	47357
A5TP510	131-0608-00			TERMINAL,PIN:0.365 L X 0.025 PH BRZ GOLD	22526	47357
A5TP511	131-0608-00			TERMINAL,PIN:0.365 L X 0.025 PH BRZ GOLD	22526	47357
A5U2008	156-1566-00			MICROCIRCUIT,DI:EPROM,100 X 14	80009	156-1566-00
A5U2034	156-0865-02			MICROCIRCUIT,DI:OCTAL D-TYPE FF W/CLEAR	01295	SN74LS273NP3
A5U2092	156-1342-01			MICROCIRCUIT,DI:MPU,8 BIT W/CLK	07263	F68A08(P OR D)
A5U2108	156-1220-00			MICROCIRCUIT,DI:HEX BUS DRIVER	01295	SN74LS365A
A5U2118	156-1245-00			MICROCIRCUIT,LI:7 XSTR,HV/HIGH CUR	04713	MC1413PDS
A5U2134	156-0865-02			MICROCIRCUIT,DI:OCTAL D-TYPE FF W/CLEAR	01295	SN74LS273NP3
A5U2162	160-1628-03	B010100	B010999	MICROCIRCUIT,DI:8K X 8 EPROM,PRGM	80009	160-1628-03
A5U2162	160-1628-04	B011000	B012499	MICROCIRCUIT,DI:8K X 8 EPROM,PRGM	80009	160-1628-04
A5U2162	160-1628-06	B012500		MICROCIRCUIT,DI:4096 X 8 EPROM,PRGM	80009	160-1628-06
A5U2178	160-1625-03	B010100	B010999	MICROCIRCUIT,DI:8192 X 8 EPROM PROG	80009	160-1625-03
A5U2178	160-1625-04	B011000	B012499	MICROCIRCUIT,DI:8K X 8 EPROM,PRGM	80009	160-1625-04
A5U2178	160-1625-06	B012500		MICROCIRCUIT,DI:8192 X 8 EPROM PROG	80009	160-1625-06

Replaceable Electrical Parts—2445 Service

Component No.	Tektronix Part No.	Serial/Model No.		Name & Description	Mfr Code	Mfr Part Number
		Eff	Dscont			
A5U2194	156-0956-02			MICROCIRCUIT,DI:OCTAL BFR W/3 STATE OUT	01295	SN74LS244NP3
A5U2208	156-0391-02			MICROCIRCUIT,DI:HEX LATCH W/CLEAR	01295	SN74LS174
A5U2214	156-1126-01			MICROCIRCUIT,LI:VOLTAGE COMPARATOR,SEL	01295	LM311JG4
A5U2234	156-1589-00			MICROCIRCUIT,LI:DA CONVERTER,12 BIT,HI SPD	34335	AM6012PC
A5U2294	156-1065-01			MICROCIRCUIT,DI:OCTAL D TYPE TRANS LATCHES	34335	AM74LS373
A5U2308	156-0391-02			MICROCIRCUIT,DI:HEX LATCH W/CLEAR	01295	SN74LS174
A5U2335	156-0513-02			MICROCIRCUIT,DI:8-CHANNEL MUX,SEL	80009	156-0513-02
A5U2362	160-1627-03	B010100	B010999	MICROCIRCUIT,DI:8192 X 8 EPROM,PRGM	80009	160-1627-03
A5U2362	160-1627-05	B011000	B012499	MICROCIRCUIT,DI:8192 X 8 EPROM,PRGM	80009	160-1627-05
A5U2362	160-1626-06	B012500		MICROCIRCUIT,DI:8192 X 8 EPROM,PRGM	80009	160-1626-06
A5U2378	160-1626-03	B010100	B010999	MICROCIRCUIT,DI:8192 X 8 EPROM,PRGM	80009	160-1626-03
A5U2378	160-1626-05	B011000	B012499	MICROCIRCUIT,DI:8192 X 8 EPROM,PRGM	80009	160-1626-05
A5U2378	160-1626-06	B012500		MICROCIRCUIT,DI:8192 X 8 EPROM,PRGM	80009	160-1626-06
A5U2408	156-0513-02			MICROCIRCUIT,DI:8-CHANNEL MUX,SEL	80009	156-0513-02
A5U2418	156-0513-02			MICROCIRCUIT,DI:8-CHANNEL MUX,SEL	80009	156-0513-02
A5U2427	156-1200-01			MICROCIRCUIT,LI:OPERATIONAL AMPL,QUAD	01295	TL074CN/PEP3
A5U2435	156-1200-01			MICROCIRCUIT,LI:OPERATIONAL AMPL,QUAD	01295	TL074CN/PEP3
A5U2456	156-1486-00			MICROCIRCUIT,DI:8 CHANNEL DATA SEL,SCREENED	04713	MC14512BCLD
A5U2468	156-0388-03			MICROCIRCUIT,DI:DUAL D FLIP-FLOP	07263	74LS74A
A5U2480	156-0469-02			MICROCIRCUIT,DI:3/8 LINE DC DR	01295	SN74LS138NP3
A5U2556	156-0385-02			MICROCIRCUIT,DI:HEX INVERTER	01295	SN74LS04
A5U2580	156-0469-02			MICROCIRCUIT,DI:3/8 LINE DC DR	01295	SN74LS138NP3
A5U2596	156-1026-02			MICROCIRCUIT,DI:4/1 LINE DECODER,BURN-IN	80009	156-1026-02
A5U2634	156-1191-01			MICROCIRCUIT,LI:DUAL BI-FET OP-AMP,8 DIP	01295	TL072ACP3
A5U2656	156-0804-02			MICROCIRCUIT,DI:QUADRUPLE S-R LATCH,SCRN	01295	SN74LS279NP3
A5U2668	156-0895-01			MICROCIRCUIT,DI:14 BIT BINARY CNTR,BURN-IN	04713	MC14020BCLD
A5U2770	156-0469-02			MICROCIRCUIT,DI:3/8 LINE DC DR	01295	SN74LS138NP3
A5VR2003	152-0127-00			SEMICONV DEVICE:ZENER,0.4W,7.5V,5%	04713	SZG35009K2
A5VR2526	152-0278-00			SEMICONV DEVICE:ZENER,0.4W,3V,5%	04713	SZG35009K20
A5W2143	131-0566-00			BUS CONDUCTOR:DUMMY RES,2.375,22 AWG	57668	JWW-0200E0
A5W2526	131-0566-00			BUS CONDUCTOR:DUMMY RES,2.375,22 AWG	57668	JWW-0200E0
A5Y2568	158-0248-00			XTAL UNIT,QTZ:10MHZ, 0.01%,SERIES	80009	158-0248-00

Replaceable Electrical Parts—2445 Service

Component No.	Tektronix Part No.	Serial/Model No. Eff Dscont	Name & Description	Mfr Code	Mfr Part Number
A6	-----		CKT BOARD ASSY:FRONT PANEL		
A6	-----		(AVAILABLE AT 672-1038-XX LEVEL ONLY)		
A6CR3000	152-0141-02		SEMICONV DEVICE:SILICON,30V,150MA	01295	1N4152R
A6CR3001	152-0141-02		SEMICONV DEVICE:SILICON,30V,150MA	01295	1N4152R
A6CR3002	152-0141-02		SEMICONV DEVICE:SILICON,30V,150MA	01295	1N4152R
A6CR3003	152-0141-02		SEMICONV DEVICE:SILICON,30V,150MA	01295	1N4152R
A6CR3010	152-0141-02		SEMICONV DEVICE:SILICON,30V,150MA	01295	1N4152R
A6CR3011	152-0141-02		SEMICONV DEVICE:SILICON,30V,150MA	01295	1N4152R
A6CR3012	152-0141-02		SEMICONV DEVICE:SILICON,30V,150MA	01295	1N4152R
A6CR3013	152-0141-02		SEMICONV DEVICE:SILICON,30V,150MA	01295	1N4152R
A6CR3020	152-0141-02		SEMICONV DEVICE:SILICON,30V,150MA	01295	1N4152R
A6CR3021	152-0141-02		SEMICONV DEVICE:SILICON,30V,150MA	01295	1N4152R
A6CR3022	152-0141-02		SEMICONV DEVICE:SILICON,30V,150MA	01295	1N4152R
A6CR3023	152-0141-02		SEMICONV DEVICE:SILICON,30V,150MA	01295	1N4152R
A6CR3025	152-0141-02		SEMICONV DEVICE:SILICON,30V,150MA	01295	1N4152R
A6CR3030	152-0141-02		SEMICONV DEVICE:SILICON,30V,150MA	01295	1N4152R
A6CR3031	152-0141-02		SEMICONV DEVICE:SILICON,30V,150MA	01295	1N4152R
A6CR3032	152-0141-02		SEMICONV DEVICE:SILICON,30V,150MA	01295	1N4152R
A6CR3033	152-0141-02		SEMICONV DEVICE:SILICON,30V,150MA	01295	1N4152R
A6CR3035	152-0141-02		SEMICONV DEVICE:SILICON,30V,150MA	01295	1N4152R
A6CR3050	152-0141-02		SEMICONV DEVICE:SILICON,30V,150MA	01295	1N4152R
A6CR3075	152-0141-02		SEMICONV DEVICE:SILICON,30V,150MA	01295	1N4152R
A6CR3105	152-0141-02		SEMICONV DEVICE:SILICON,30V,150MA	01295	1N4152R
A6CR3110	152-0141-02		SEMICONV DEVICE:SILICON,30V,150MA	01295	1N4152R
A6CR3115	152-0141-02		SEMICONV DEVICE:SILICON,30V,150MA	01295	1N4152R
A6CR3120	152-0141-02		SEMICONV DEVICE:SILICON,30V,150MA	01295	1N4152R
A6CR3175	152-0141-02		SEMICONV DEVICE:SILICON,30V,150MA	01295	1N4152R
A6CR3176	152-0141-02		SEMICONV DEVICE:SILICON,30V,150MA	01295	1N4152R
A6CR3177	152-0141-02		SEMICONV DEVICE:SILICON,30V,150MA	01295	1N4152R
A6CR3178	152-0141-02		SEMICONV DEVICE:SILICON,30V,150MA	01295	1N4152R
A6CR3179	152-0141-02		SEMICONV DEVICE:SILICON,30V,150MA	01295	1N4152R
A6CR3180	152-0141-02		SEMICONV DEVICE:SILICON,30V,150MA	01295	1N4152R
A6CR3181	152-0141-02		SEMICONV DEVICE:SILICON,30V,150MA	01295	1N4152R
A6CR3182	152-0141-02		SEMICONV DEVICE:SILICON,30V,150MA	01295	1N4152R
A6CR3183	152-0141-02		SEMICONV DEVICE:SILICON,30V,150MA	01295	1N4152R
A6CR3184	152-0141-02		SEMICONV DEVICE:SILICON,30V,150MA	01295	1N4152R
A6CR3185	152-0141-02		SEMICONV DEVICE:SILICON,30V,150MA	01295	1N4152R
A6CR3200	152-0141-02		SEMICONV DEVICE:SILICON,30V,150MA	01295	1N4152R
A6CR3210	152-0141-02		SEMICONV DEVICE:SILICON,30V,150MA	01295	1N4152R
A6CR3220	152-0141-02		SEMICONV DEVICE:SILICON,30V,150MA	01295	1N4152R
A6CR3250	152-0141-02		SEMICONV DEVICE:SILICON,30V,150MA	01295	1N4152R
A6CR3260	152-0141-02		SEMICONV DEVICE:SILICON,30V,150MA	01295	1N4152R
A6CR3270	152-0141-02		SEMICONV DEVICE:SILICON,30V,150MA	01295	1N4152R
A6DS3300	150-1109-00		LT EMITTING DIO:GREEN, 30MA	73138	SP732
A6DS3301	150-1109-00		LT EMITTING DIO:GREEN, 30MA	73138	SP732
A6DS3302	150-1109-00		LT EMITTING DIO:GREEN, 30MA	73138	SP732
A6DS3303	150-1109-00		LT EMITTING DIO:GREEN, 30MA	73138	SP732
A6DS3304	150-1105-00		LT EMITTING DIO:YELLOW,30MA	50434	QLMP-0449
A6DS3310	150-1109-00		LT EMITTING DIO:GREEN, 30MA	73138	SP732
A6DS3311	150-1109-00		LT EMITTING DIO:GREEN, 30MA	73138	SP732
A6DS3312	150-1109-00		LT EMITTING DIO:GREEN, 30MA	73138	SP732
A6DS3313	150-1109-00		LT EMITTING DIO:GREEN, 30MA	73138	SP732
A6DS3314	150-1105-00		LT EMITTING DIO:YELLOW,30MA	50434	QLMP-0449

Replaceable Electrical Parts—2445 Service

Component No.	Tektronix Part No.	Serial/Model No. Eff	Dscont	Name & Description	Mfr Code	Mfr Part Number
A6DS3325	150-1109-00			LT EMITTING DIO:GREEN, 30MA	73138	SP732
A6DS3326	150-1109-00			LT EMITTING DIO:GREEN, 30MA	73138	SP732
A6DS3327	150-1109-00			LT EMITTING DIO:GREEN, 30MA	73138	SP732
A6DS3328	150-1105-00	B020000		LT EMITTING DIO:YELLOW,30MA	50434	QLMP-0449
A6DS3329	150-1105-00	B020000		LT EMITTING DIO:YELLOW,30MA	50434	QLMP-0449
A6DS3330	150-1109-00			LT EMITTING DIO:GREEN, 30MA	73138	SP732
A6DS3331	150-1109-00			LT EMITTING DIO:GREEN, 30MA	73138	SP732
A6DS3332	150-1109-00	B020000		LT EMITTING DIO:GREEN, 30MA	73138	SP732
A6DS3350	150-1109-00			LT EMITTING DIO:GREEN, 30MA	73138	SP732
A6DS3351	150-1105-00			LT EMITTING DIO:YELLOW,30MA	50434	QLMP-0449
A6DS3352	150-1105-00			LT EMITTING DIO:YELLOW,30MA	50434	QLMP-0449
A6DS3353	150-1105-00			LT EMITTING DIO:YELLOW,30MA	50434	QLMP-0449
A6DS3354	150-1109-00			LT EMITTING DIO:GREEN, 30MA	73138	SP732
A6DS3355	150-1109-00	B020000		LT EMITTING DIO:GREEN, 30MA	73138	SP732
A6DS3356	150-1109-00	B020000		LT EMITTING DIO:GREEN, 30MA	73138	SP732
A6DS3357	150-1109-00	B020000		LT EMITTING DIO:GREEN, 30MA	73138	SP732
A6DS3375	150-1105-00			LT EMITTING DIO:YELLOW,30MA	50434	QLMP-0449
A6DS3376	150-1109-00			LT EMITTING DIO:GREEN, 30MA	73138	SP732
A6DS3377	150-1109-00			LT EMITTING DIO:GREEN, 30MA	73138	SP732
A6DS3378	150-1109-00			LT EMITTING DIO:GREEN, 30MA	73138	SP732
A6DS3379	150-1109-00			LT EMITTING DIO:GREEN, 30MA	73138	SP732
A6DS3380	150-1105-00			LT EMITTING DIO:YELLOW,30MA	50434	QLMP-0449
A6DS3390	150-1105-00			LT EMITTING DIO:YELLOW,30MA	50434	QLMP-0449
A6DS3391	150-1109-00			LT EMITTING DIO:GREEN, 30MA	73138	SP732
A6DS3392	150-1109-00			LT EMITTING DIO:GREEN, 30MA	73138	SP732
A6DS3393	150-1109-00			LT EMITTING DIO:GREEN, 30MA	73138	SP732
A6R3021	311-2180-00			RES.,VAR,NONWW:LINEAR,2K OHM,30%,0.5W	32997	91Z1A-Z45-EA0019
A6R3031	311-2180-00			RES.,VAR,NONWW:LINEAR,2K OHM,30%,0.5W	32997	91Z1A-Z45-EA0019
A6R3050	311-2180-00			RES.,VAR,NONWW:LINEAR,2K OHM,30%,0.5W	32997	91Z1A-Z45-EA0019
A6R3075	311-2180-00			RES.,VAR,NONWW:LINEAR,2K OHM,30%,0.5W	32997	91Z1A-Z45-EA0019
A6R3100	311-2180-00			RES.,VAR,NONWW:LINEAR,2K OHM,30%,0.5W	32997	91Z1A-Z45-EA0019
A6R3125	311-2181-00			RES.,VAR,NONWW:LINEAR,5K OHM,30%,0.25W	32997	91Z2D-Z45-EA0020
A6R3150	311-2181-00			RES.,VAR,NONWW:LINEAR,5K OHM,30%,0.25W	32997	91Z2D-Z45-EA0020
A6R3190	311-2180-00			RES.,VAR,NONWW:LINEAR,2K OHM,30%,0.5W	32997	91Z1A-Z45-EA0019
A6R3200	311-2182-00			RES.,VAR,NONWW:LINEAR,5K OHM,30%,0.5W	32997	91Z2D-Z45-EA0021
A6R3210	311-2180-00			RES.,VAR,NONWW:LINEAR,2K OHM,30%,0.5W	32997	91Z1A-Z45-EA0019
A6R3300	315-0151-00			RES.,FXD,CMPSN:150 OHM,5%,0.25W	01121	CB1515
A6R3310	315-0151-00			RES.,FXD,CMPSN:150 OHM,5%,0.25W	01121	CB1515
A6R3325	315-0151-00	B020000		RES.,FXD,CMPSN:150 OHM,5%,0.25W	01121	CB1515
A6R3326	315-0151-00			RES.,FXD,CMPSN:150 OHM,5%,0.25W	01121	CB1515
A6R3327	315-0151-00	B010100	B01999	RES.,FXD,CMPSN:150 OHM,5%,0.25W	01121	CB1515
A6R3329	315-0151-00	B020000		RES.,FXD,CMPSN:150 OHM,5%,0.25W	01121	CB1515
A6R3350	307-0611-00	B010100	B01999	RES NTWK,FXD FI:7,150 OHM,5%,1.125W	32997	4308R101-151J
A6R3350	307-0695-00	B020000		RES NTWK,FXD FI:9,150 OHM,2%,0.2W EACH	01121	110A151
A6S3000	260-2094-00			SWITCH,PUSH:4 BTN,SINGLE POLE,VERT CONT	80009	260-2094-00
A6S3010	260-2094-00			SWITCH,PUSH:4 BTN,SINGLE POLE,VERT CONT	80009	260-2094-00
A6S3020	260-2086-00			SWITCH,ROTARY:VOLTS/DIV	76784	T-51621-001
A6S3025	260-2100-00			SWITCH,LEVER:DPDT,1 SECT,3 POSN,30 DEG	22753	OBD
A6S3030	260-2086-00			SWITCH,ROTARY:VOLTS/DIV	76784	T-51621-001
A6S3035	260-2100-00			SWITCH,LEVER:DPDT,1 SECT,3 POSN,30 DEG	22753	OBD
A6S3050	260-2095-00			SWITCH,PUSH:2 BTN,SINGLE POLE,CHAN 3 &4	80009	260-2095-00
A6S3105	260-2087-00			SWITCH,PUSH:1 SINGLE BTN,SINGLE POLE,H0	80009	260-2087-00
A6S3110	260-2093-00			SWITCH,PUSH:3 BTN,SINGLE POLE,HORIZ	80009	260-2093-00

Replaceable Electrical Parts—2445 Service

Component No.	Tektronix Part No.	Serial/Model No. Eff	Dscont	Name & Description	Mfr Code	Mfr Part Number
A6S3175	260-2085-00			SWITCH,ROTARY:TIME/DIV	76854	5-51625-001
A6S3185	260-2108-00	B010100	B019999	SWITCH,PUSH:SPST,0.1A,125VAC	80009	260-2108-00
A6S3185	260-2108-01	B020000				
A6S3210	260-2088-00			SWITCH,PUSH:SINGLE BTN,SINGLE POLE,TRIG	80009	260-2088-00
A6S3220	260-2088-00			SWITCH,PUSH:SINGLE BTN,SINGLE POLE,TRIG	80009	260-2088-00
A6S3250	260-2100-00			SWITCH,LEVER:DPDT,1 SECT,3 POSN,30 DEG	22753	OBD
A6S3260	260-2100-00			SWITCH,LEVER:DPDT,1 SECT,3 POSN,30 DEG	22753	OBD
A6S3270	260-2100-00			SWITCH,LEVER:DPDT,1 SECT,3 POSN,30 DEG	22753	OBD
A6U3300	156-0651-02			MICROCIRCUIT,DI:8 BIT PRL-OUT SER SHF RGTR	01295	SN74LS164(NP3 OR
A6U3325	156-0651-02			MICROCIRCUIT,DI:8 BIT PRL-OUT SER SHF RGTR	01295	SN74LS164(NP3 OR
A6U3350	156-0651-02			MICROCIRCUIT,DI:8 BIT PRL-OUT SER SHF RGTR	01295	SN74LS164(NP3 OR
A6U3375	156-0651-02			MICROCIRCUIT,DI:8 BIT PRL-OUT SER SHF RGTR	01295	SN74LS164(NP3 OR
A6W651	175-4584-00	B010100	B019999	CA ASSY,SP,ELEC:20,28 AWG,4.0 L	80009	175-4584-00
A6W651	175-8419-00	B020000		CA ASSY,SP,ELEC:26,28 AWG,2.5 L,RIBBON	80009	175-8419-00
A6W652	175-4582-00	B010100	B019999	CA ASSY,SP,ELEC:26,28 AWG,8.5 L	80009	175-4582-00
A6W652	175-8418-00	B020000		CA ASSY,SP,ELEC:20,28 AWG,8.0 L,RIBBON	80009	175-8418-00

Replaceable Electrical Parts—2445 Service

Component No.	Tektronix Part No.	Serial/Model No. Eff Dscont	Name & Description	Mfr Code	Mfr Part Number
A7	670-7284-00		CKT BOARD ASSY:FRONT PANEL VARIABLE	80009	670-7284-00
A7R3420	311-2183-00		RES.,VAR,NONWW:LINEAR,5K OHM,30%,0.5W	32997	91ZID-Z36-EA0024
A7R3430	311-2183-00		RES.,VAR,NONWW:LINEAR,5K OHM,30%,0.5W	32997	91ZID-Z36-EA0024
A7R3475	311-2183-00		RES.,VAR,NONWW:LINEAR,5K OHM,30%,0.5W	32997	91ZID-Z36-EA0024
A8	670-7280-00		CKT BOARD ASSY:SCALE ILLUMINATION	80009	670-7280-00
A8DS90	150-0030-00		LAMP,GLOW:NEON,T-2,60 TO 90 VOLTS	74276	NE2V-T
A8DS90	-----		(SUBPART OF HV MODULE 152-0805-00)		
A8DS91	150-0030-00		LAMP,GLOW:NEON,T-2,60 TO 90 VOLTS	74276	NE2V-T
A8DS91	-----		(SUBPART OF HV MODULE 152-0805-00)		
A8DS100	150-0057-01		LAMP,INCAND:5V,0.115A,WIRE LD,SEL	76854	17AS15
A8DS101	150-0057-01		LAMP,INCAND:5V,0.115A,WIRE LD,SEL	76854	17AS15
A8DS102	150-0057-01		LAMP,INCAND:5V,0.115A,WIRE LD,SEL	76854	17AS15

Replaceable Electrical Parts—2445 Service

Component No.	Tektronix Part No.	Serial/Model No. Eff	Dscont	Name & Description	Mfr Code	Mfr Part Number
A9	670-7277-00	B010100	B010999	CKT BOARD ASSY:HIGH VOLTAGE	80009	670-7277-00
A9	670-7277-01	B011000	B012149	CKT BOARD ASSY:HIGH VOLTAGE	80009	670-7277-01
A9	670-7277-02	B012150	B013249	CKT BOARD ASSY:HIGH VOLTAGE	80009	670-7277-02
A9	670-7277-03	B013250		CKT BOARD ASSY:HIGH VOLTAGE	80009	670-7277-03
A9C90	283-0115-00	B010100	B012149	CAP.,FXD,CER DI:47PF,5%,200V	59660	805-519-C0G0470J
A9C91	283-0084-00			CAP.,FXD,CER DI:270PF,5%,1000V	59660	838 533X5F0 2715
A9C1812	285-1236-00			CAP.,FXD,PLSTC:0.022UF,20%,400V	84411	TEK-245-22304
A9C1813	285-1236-00			CAP.,FXD,PLSTC:0.022UF,20%,400V	84411	TEK-245-22304
A9C1886	285-1236-00			CAP.,FXD,PLSTC:0.022UF,20%,400V	84411	TEK-245-22304
A9C1888	285-1236-00			CAP.,FXD,PLSTC:0.022UF,20%,400V	84411	TEK-245-22304
A9C1889	285-1236-00			CAP.,FXD,PLSTC:0.022UF,20%,400V	84411	TEK-245-22304
A9C1890	281-0775-00			CAP.,FXD,CER DI:0.1UF,20%,50V	04222	MA205E104MAA
A9C1891	281-0775-00	B010100	B013649	CAP.,FXD,CER DI:0.1UF,20%,50V	04222	MA205E104MAA
A9C1891	281-0773-00	B013650		CAP.,FXD,CER DI:0.01UF,10%,100V	04222	MA201C103KAA
A9C1909	281-0783-00			CAP.,FXD,CER DI:0.1UF,20%,100V	96733	ADVISE
A9C1912	281-0798-00			CAP.,FXD,CER DI:51PF,1%,100V	96733	R2928
A9C1915	281-0783-00	B011000		CAP.,FXD,CER DI:0.1UF,20%,100V	96733	ADVISE
A9C1932	281-0775-00			CAP.,FXD,CER DI:0.1UF,20%,50V	04222	MA205E104MAA
A9C1950	281-0766-00			CAP.,FXD,CER DI:100PF,20%,200V	04222	GC106C101M
A9C1951	290-0269-00			CAP.,FXD,ELCTLT:0.22UF,5%,35V	56289	173D224X505035U
A9C1971	285-1236-00			CAP.,FXD,PLSTC:0.022UF,20%,400V	84411	TEK-245-22304
A9C1972	290-0747-00			CAP.,FXD,ELCTLT:100UF,+50-10%,25V	56289	500D148
A9C1973	281-0771-00			CAP.,FXD,CER DI:0.0022UF,20%,200V	56289	292C Z5U222M200B
A9C1980	281-0773-00			CAP.,FXD,CER DI:0.01UF,10%,100V	04222	MA201C103KAA
A9C1990	285-1096-00			CAP.,FXD,PLSTC:1UF,10%,50V	14752	230B1A105K
A9C1991	281-0771-00			CAP.,FXD,CER DI:0.0022UF,20%,200V	56289	292C Z5U222M200B
A9CR1894	152-0400-00			SEMICONV DEVICE:SILICON,400V,1A	80009	152-0400-00
A9CR1895	152-0400-00			SEMICONV DEVICE:SILICON,400V,1A	80009	152-0400-00
A9CR1915	152-0061-00	B011000		SEMICONV DEVICE:SILICON,175V,100MA	07263	FDH2161
A9CR1930	152-0061-00			SEMICONV DEVICE:SILICON,175V,100MA	07263	FDH2161
A9CR1950	152-0061-00			SEMICONV DEVICE:SILICON,175V,100MA	07263	FDH2161
A9CR1951	152-0787-00	B010100	B010477	SEMICONV DEVICE:RECT,SI,12KV,3MA,A-LZV	000JF	ESJA25-12
A9CR1953	152-0061-00			SEMICONV DEVICE:SILICON,175V,100MA	07263	FDH2161
A9CR1990	152-0141-02			SEMICONV DEVICE:SILICON,30V,150MA	01295	1N4152R
A9DS90	150-0030-00			LAMP,GLOW:NEON,T-2.60 TO 90 VOLTS	74276	NE2V-T
A9DS91	150-0030-00			LAMP,GLOW:NEON,T-2.60 TO 90 VOLTS	74276	NE2V-T
A9L1974	108-0318-00			COIL,RF,CMPSN:100 OHM, 5%, 0.25W	32159	81000M
A9Q1851	151-0443-00			TRANSISTOR:SILICON,PNP	04713	SPS7950
A9Q1852	151-0443-00			TRANSISTOR:SILICON,PNP	04713	SPS7950
A9Q1890	151-0443-00			TRANSISTOR:SILICON,PNP	04713	SPS7950
A9Q1980	151-0444-00			TRANSISTOR:SILICON,NPN	04713	SPS797
A9Q1981	151-0745-00			TRANSISTOR:SILICON,PNP	000IG	2SA1077G
A9R1812	315-0100-02			RES.,FXD,CMPSN:10 OHM,5%,0.25W	01121	CB1005
A9R1813	315-0100-02			RES.,FXD,CMPSN:10 OHM,5%,0.25W	01121	CB1005
A9R1820	315-0122-00			RES.,FXD,CMPSN:1.2K OHM,5%,0.25W	01121	CB1225
A9R1830	307-0110-00	B010100	B013249	RES.,FXD,CMPSN:3 OHM,5%,0.25W	01121	CB30G5
A9R1834	311-1227-00			RES.,VAR,NONWIR:5K OHM,20%,0.50W	32997	3386F-T04-502
A9R1842	311-1227-00			RES.,VAR,NONWIR:5K OHM,20%,0.50W	32997	3386F-T04-502

Replaceable Electrical Parts—2445 Service

Component No.	Tektronix	Serial/Model No.		Name & Description	Mfr Code	Mfr Part Number
	Part No.	Eff	Dscont			
A9R1848	311-1227-00			RES.,VAR, NONWIR:5K OHM,20%,0.50W	32997	3386F-T04-502
A9R1853	321-0447-00			RES.,FXD,FILM:442K OHM,1%,0.125W	24546	NA55D4423F
A9R1854	321-0435-00			RES.,FXD,FILM:332K OHM,1%,0.125W	91637	MFF1816G33202F
A9R1855	321-0407-00			RES.,FXD,FILM:169K OHM,1%,0.125W	91637	MFF1816G16902F
A9R1856	321-0367-00			RES.,FXD,FILM:64.9K OHM,1%,0.125W	91637	MFF1816G64901F
A9R1857	321-0364-00			RES.,FXD,FILM:60.4K OHM,1%,0.125W	91637	CMF55116G60401F
A9R1858	315-0105-00			RES.,FXD,CMPSN:1M OHM,5%,0.25W	01121	CB1055
A9R1864	311-1230-00			RES.,VAR, NONWIR:20K OHM,20%,0.50W	32997	3386F-T04-203
A9R1870	311-1214-00			RES.,VAR, NONWIR:200K OHM,20%,0.50W	73138	72-16-0
A9R1871	315-0154-00			RES.,FXD,CMPSN:150K OHM,5%,0.25W	01121	CB1545
A9R1872	315-0184-00			RES.,FXD,CMPSN:180K OHM,5%,0.25W	01121	CB1845
A9R1873	315-0103-00			RES.,FXD,CMPSN:10K OHM,5%,0.25W	01121	CB1035
A9R1878	311-1214-00			RES.,VAR, NONWIR:200K OHM,20%,0.50W	73138	72-16-0
A9R1880	315-0434-00			RES.,FXD,CMPSN:430K OHM,5%,0.25W	01121	CB4345
A9R1881	321-0385-00			RES.,FXD,FILM:100K OHM,1%,0.125W	91637	MFF1816G10002F
A9R1890	315-0473-00			RES.,FXD,CMPSN:47K OHM,5%,0.25W	01121	CB4735
A9R1891	321-0481-04			RES.,FXD,FILM:1M OHM,0.1%,0.125W	91637	CMF55116D10003B
A9R1892	321-0693-00			RES.,FXD,FILM:68.1K OHM,0.5%,0.125W	91637	CMF55-116G68101D
A9R1893	321-0481-04			RES.,FXD,FILM:1M OHM,0.1%,0.125W	91637	CMF55116D10003B
A9R1895	315-0123-00			RES.,FXD,CMPSN:12K OHM,5%,0.25W	01121	CB1235
A9R1896	315-0100-02			RES.,FXD,CMPSN:10 OHM,5%,0.25W	01121	CB1005
A9R1897	315-0102-00			RES.,FXD,CMPSN:1K OHM,5%,0.25W	01121	CB1025
A9R1898	315-0102-00			RES.,FXD,CMPSN:1K OHM,5%,0.25W	01121	CB1025
A9R1910	321-0271-00			RES.,FXD,FILM:6.49K OHM,1%,0.125W	91637	MFF1816G64900F
A9R1911	321-0245-00			RES.,FXD,FILM:3.48K OHM,1%,0.125W	91637	MFF1816G34800F
A9R1913	315-0101-03	B011000		RES.,FXD,CMPSN:100 OHM,5%,0.25W	01121	CB1015
A9R1920	315-0152-00			RES.,FXD,CMPSN:1.5K OHM,5%,0.25W	01121	CB1525
A9R1921	315-0100-02			RES.,FXD,CMPSN:10 OHM,5%,0.25W	01121	CB1005
A9R1922	315-0101-06	B010100	0 B01079	RES.,FXD,CMPSN:100 OHM,5%,0.25W	01121	CB1015
A9R1922	315-0331-03	B010800		RES.,FXD,CMPSN:330 OHM,5%,0.25W	01121	CB3315
A9R1933	315-0102-00			RES.,FXD,CMPSN:1K OHM,5%,0.25W	01121	CB1025
A9R1941	315-0201-00			RES.,FXD,CMPSN:200 OHM,5%,0.25W	01121	CB2015
A9R1944	315-0163-00			RES.,FXD,CMPSN:16K OHM,5%,0.25W	01121	CB1635
A9R1945	321-0385-07			RES.,FXD,FILM:100K OHM,0.1%,0.125W	91637	MFF1816C10002B
A9R1950	315-0103-00			RES.,FXD,CMPSN:10K OHM,5%,0.25W	01121	CB1035
A9R1951	315-0220-00			RES.,FXD,CMPSN:22 OHM,5%,0.25W	01121	CB2205
A9R1952	315-0202-00			RES.,FXD,CMPSN:2K OHM,5%,0.25W	01121	CB2025
A9R1953	315-0393-00			RES.,FXD,CMPSN:39K OHM,5%,0.25W	01121	CB3935
A9R1971	315-0202-00			RES.,FXD,CMPSN:2K OHM,5%,0.25W	01121	CB2025
A9R1972	315-0224-00			RES.,FXD,CMPSN:220K OHM,5%,0.25W	01121	CB2245
A9R1973	315-0163-00			RES.,FXD,CMPSN:16K OHM,5%,0.25W	01121	CB1635
A9R1990	321-0693-00			RES.,FXD,FILM:68.1K OHM,0.5%,0.125W	91637	CMF55-116G68101D
A9R1991	315-0107-00			RES.,FXD,CMPSN:100M OHM,5%,0.25W	01121	CB1075
A9R1992	315-0244-00			RES.,FXD,CMPSN:240K OHM,5%,0.25W	01121	CB2445
A9R1994	321-0402-00			RES.,FXD,FILM:150K OHM,1%,0.125W	24546	NA55D1503F
A9T1970	120-1418-00	B010100	B013249	XFMR,PWR SU&SDN:HIGH VOLTAGE	80009	120-1418-00
A9T1970	120-1418-01	B013250		XFMR,PWR SU&SDN:HIGH VOLTAGE	80009	120-1418-01
A9U1890	156-1191-01			MICROCIRCUIT,LI:DUAL BI-FET OP-AMP,8 DIP	01295	TL072ACP3
A9U1956	156-0158-07			MICROCIRCUIT,LI:DUAL OPNL AMPL,SCREENED	01295	MC1458JG4
A9U1830	152-0805-00			SEMICONV DEVICE:HV MULTIPLIER,20KV INPUT	80009	152-0805-00
A9VR1891	152-0282-00			SEMICONV DEVICE:ZENER,0.4W,30V,5%	14552	1N972B
A9W1909	131-0566-00			BUS CONDUCTOR:DUMMY RES,2.375,22 AWG	57668	JWW-0200E0

Replaceable Electrical Parts—2445 Service

Component No.	Tektronix Part No.	Serial/Model No. Eff Dscont	Name & Description	Mfr Code	Mfr Part Number
A10	670-7390-00		CKT BOARD ASSY:FAN MOTOR	80009	670-7390-00
A10B1690	147-0035-00		MOTOR,DC:BRUSHLESS,10-15VDC,145MA	25088	1AD3001-0A
A10C1698	290-0804-00		CAP.,FXD,ELCTLT:10UF,+50-10%,25V	55680	ULA1E100TEA
A10CR1691	152-0141-02		SEMICONV DEVICE:SILICON,30V,150MA	01295	1N4152R
A10CR1692	152-0141-02		SEMICONV DEVICE:SILICON,30V,150MA	01295	1N4152R
A10CR1694	152-0141-02		SEMICONV DEVICE:SILICON,30V,150MA	01295	1N4152R
A10CR1696	152-0141-02		SEMICONV DEVICE:SILICON,30V,150MA	01295	1N4152R
A10CR1699	152-0141-02		SEMICONV DEVICE:SILICON,30V,150MA	01295	1N4152R
A10Q1698	151-0301-00		TRANSISTOR:SILICON,PNP	27014	2N2907A
A10R1691	303-0150-00		RES.,FXD,CMPSN:15 OHM,5%,1W	01121	GB1505
A10R1692	321-0062-00		RES.,FXD,FILM:43.2 OHM,1%,0.125W	91637	CMF55-116G43R20F
A10R1693	323-0155-00		RES.,FXD,FILM:402 OHM,1%,0.50W	75042	CECT0-4020F
A10R1694	323-0155-00		RES.,FXD,FILM:402 OHM,1%,0.50W	75042	CECT0-4020F
A10R1695	321-0222-00		RES.,FXD,FILM:2K OHM,1%,0.125W	91637	MFF1816G20000F
A10R1697	321-0190-00		RES.,FXD,FILM:931 OHM,1%,0.125W	91637	MFF1816G931R0F
A10RT1696	307-0124-00		RES.,THERMAL:5K OHM,10%	50157	1D1618
A10U1690	156-0281-00		MICROCIRCUIT,LI:4 TRANSISTOR ARRAY	02735	89164
A13	307-1154-00		PASSIVE NETWORK:CRT TERMINATOR,FINISHED	80009	307-1154-00

Replaceable Electrical Parts—2445 Service

Component No.	Tektronix Part No.	Serial/Model No.		Name & Description	Mfr Code	Mfr Part Number
		Eff	Dscont			
A14	670-8000-00			CKT BOARD ASSY:DYNAMIC CENTERING	80009	670-8000-00
A14C3401	283-0421-00			CAP.,FXD,CER DI:0.1UF,+80-20%,50V	04222	DG015E104Z
A14R3401	311-1137-00			RES.,VAR,NONWIR:5K OHM,20%,0.50W	73138	72PX-67-0-502M
A14R3402	315-0222-00			RES.,FXD,CMPSN:2.2K OHM,5%,0.25W	01121	CB2225
A14R3403	315-0750-00			RES.,FXD,CMPSN:75 OHM,5%,0.25W	01121	CB7505
A14R3404	321-0284-00			RES.,FXD,FILM:8.87K OHM,1%,0.125W	91637	MFF1816G88700F
A14R3405	315-0750-00			RES.,FXD,CMPSN:75 OHM,5%,0.25W	01121	CB7505
A14R3406	315-0123-00			RES.,FXD,CMPSN:12K OHM,5%,0.25W	01121	CB1235
A14R3407	311-1137-00			RES.,VAR,NONWIR:5K OHM,20%,0.50W	73138	72PX-67-0-502M
A14R3408	321-0284-00			RES.,FXD,FILM:8.87K OHM,1%,0.125W	91637	MFF1816G88700F
A14R3409	315-0222-00			RES.,FXD,CMPSN:2.2K OHM,5%,0.25W	01121	CB2225
A14R3410	315-0103-00			RES.,FXD,CMPSN:10K OHM,5%,0.25W	01121	CB1035
A14R3411	315-0103-00			RES.,FXD,CMPSN:10K OHM,5%,0.25W	01121	CB1035
A14U3401	156-0130-02			MICROCIRCUIT,LI:MODULATOR/DEMODULATOR.SCRN	04713	SC77162GH
A14U3402	156-0130-02			MICROCIRCUIT,LI:MODULATOR/DEMODULATOR.SCRN	04713	SC77162GH
A14VR3401	152-0227-00			SEMICONV DEVICE:ZENER,0.4W,6.2V,5%	04713	SZ13903

Replaceable Electrical Parts—2445 Service

Component No.	Tektronix Part No.	Serial/Model No. Eff	Dscont	Name & Description	Mfr Code	Mfr Part Number
				CHASSIS PARTS		
F90	159-0021-00			FUSE,CARTRIDGE:3AG,2A,250V,FAST-BLOW	71400	AGC 2
F90	-----			(SUBPART OF STANDARD AND OPT A4 ONLY)		
F90	159-0098-00	B010100	B01304	FUSE,CARTRIDGE:DIN,1.6A	T0946	EQ1.6
F90	-----			(SUBPART OF OPTS.A1,A2,A3,A5)		
F90	159-0229-00	B013050		FUSE,CARTRIDGE:5 X20MM,1.6A,250V,TIME/DLY	75915	213016EAK,1.6
F90	-----			(SUBPART OF OPTS.A1,A2,A3,A5)		
L90	119-1478-01			COIL,TUBE DEFL:FXD TRACE REDUCTION		
LR1513	108-1132-00			COIL,RF:FXD,TERMINATION COMP		
LR1514	108-1132-00			COIL,RF:FXD,TERMINATION COMP		
R134	311-2174-00			RES.,VAR,NONWW:5K OHM,20%,0.5W LINEAR	12697	CM43515
R351	311-2174-00			RES.,VAR,NONWW:5K OHM,20%,0.5W LINEAR	12697	CM43515
R352	311-2174-00			RES.,VAR,NONWW:5K OHM,20%,0.5W LINEAR	12697	CM43515
R975	311-1482-00			RES.,VAR,NONWIR:5K OHM,20%,0.50W	01121	W-8070
R976	311-1482-00			RES.,VAR,NONWIR:5K OHM,20%,0.50W	01121	W-8070
R977	311-2174-00			RES.,VAR,NONWW:5K OHM,20%,0.5W LINEAR	12697	CM43515
S90	260-1967-00			SWITCH,SLIDE:DPDT,5A/250V	000FJ	4021.0512
S90	-----			(SUBPART OF 672-1037-01)		
S1020	260-0907-00			SW,THERMOSTATIC:OPEN 97.8,CL 75.6,10A,240V	93410	430-349
S3185	260-2108-00			SWITCH,PUSH:SPST,0.1A,125VAC	80009	260-2108-00
V900	154-0850-00	B010100	B02045	ELECTRON TUBE:CRT	80009	154-0850-00
V900	154-0850-01	B020456		ELECTRON TUBE:CRT	80009	154-0850-01

DIAGRAMS AND CIRCUIT BOARD ILLUSTRATIONS

Symbols

Graphic symbols and class designation letters are based on ANSI Standard Y32.2-1975.

Logic symbology is based on ANSI Y32.14-1973 in terms of positive logic. Logic symbols depict the logic function performed and may differ from the manufacturer's data.

The overline on a signal name indicates that the signal performs its intended function when it is in the low state.

Abbreviations are based on ANSI Y1.1-1972.

Other ANSI standards that are used in the preparation of diagrams by Tektronix, Inc. are:

- Y14.15, 1966 Drafting Practices.
- Y14.2, 1973 Line Conventions and Lettering.
- Y10.5, 1968 Letter Symbols for Quantities Used in Electrical Science and Electrical Engineering.

American National Standard Institute
1430 Broadway
New York, New York 10018

Component Values

Electrical components shown on the diagrams are in the following units unless noted otherwise:

- Capacitors = Values one or greater are in picofarads (pF). Values less than one are in microfarads (μ F).
- Resistors = Ohms (Ω).

———— The information and special symbols below may appear in this manual. ————

Assembly Numbers and Grid Coordinates

Each assembly in the instrument is assigned an assembly number (e.g., A20). The assembly number appears on the circuit board outline on the diagram, in the title for the circuit board component location illustration, and in the lookup table for the schematic diagram and corresponding component locator illustration. The Replaceable Electrical Parts list is arranged by assemblies in numerical sequence; the components are listed by component number *(see following illustration for constructing a component number).

The schematic diagram and circuit board component location illustration have grids. A lookup table with the grid coordinates is provided for ease of locating the component. Only the components illustrated on the facing diagram are listed in the lookup table. When more than one schematic diagram is used to illustrate the circuitry on a circuit board, the circuit board illustration may only appear opposite the first diagram on which it was illustrated; the lookup table will list the diagram number of other diagrams that the circuitry of the circuit board appears on.

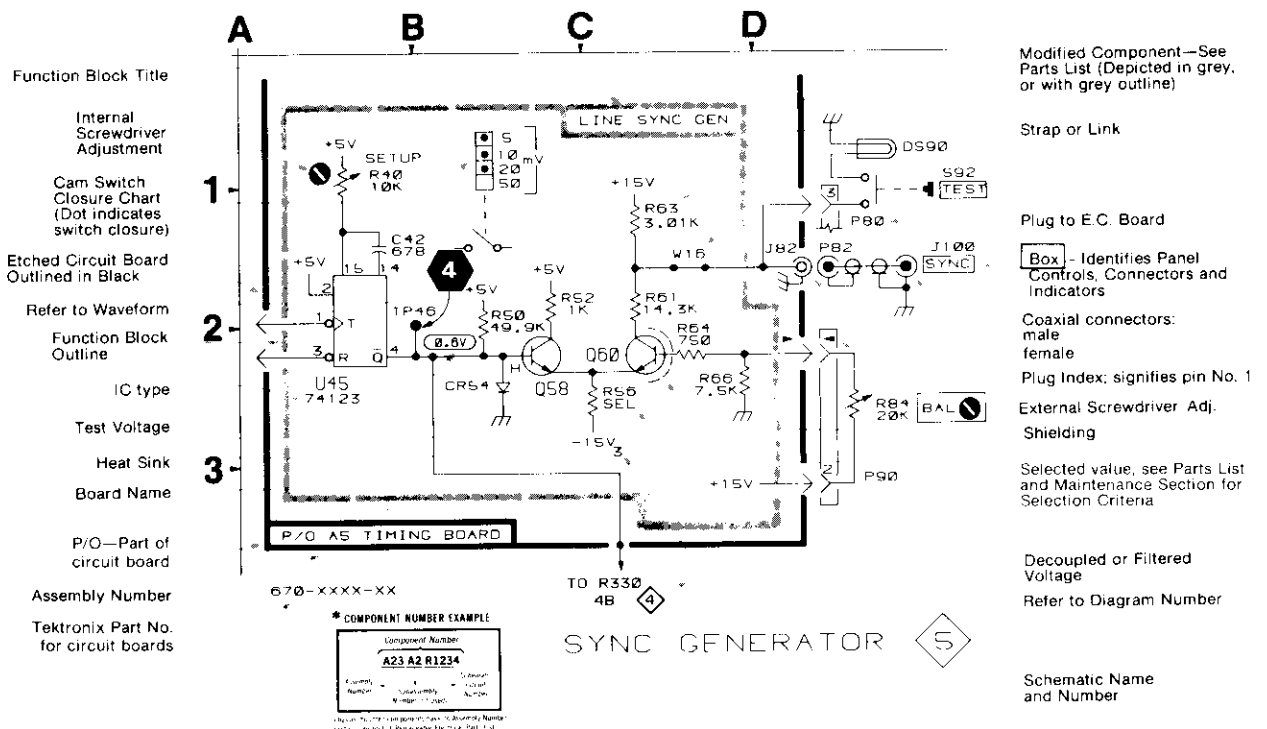

COLOR CODE

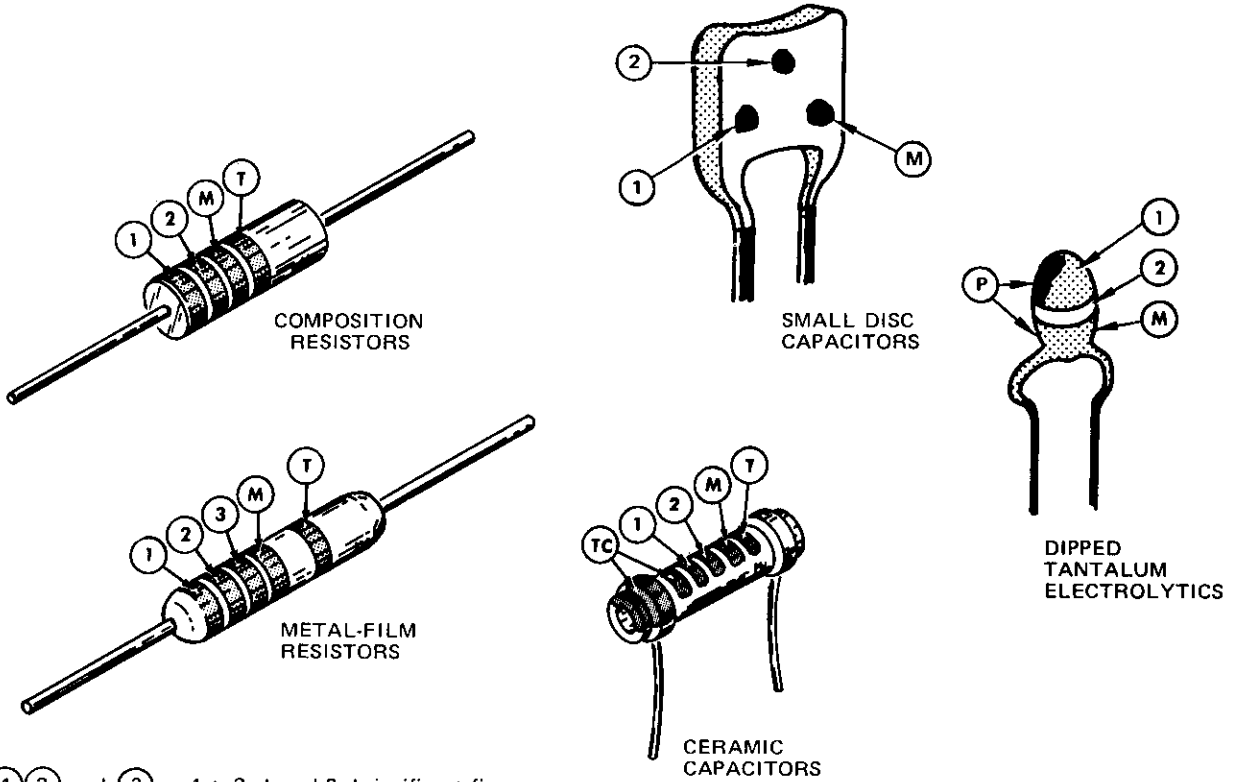

(1) (2) and (3) — 1st, 2nd, and 3rd significant figures

(M) —multiplier (T) —tolerance

(TC) —temperature coefficient

(P) —polarity and voltage rating

(T) and/or (TC) color code may not be present on some capacitors

COLOR	SIGNIFICANT FIGURES	RESISTORS		CAPACITORS			DIPPED TANTALUM VOLTAGE RATING
		MULTIPLIER	TOLERANCE	MULTIPLIER	TOLERANCE		
					over 10 pF	under 10 pF	
BLACK	0	1	----	1	±20%	±2 pF	4 VDC
BROWN	1	10	±1%	10	±1%	±0.1 pF	6 VDC
RED	2	10 ² or 100	±2%	10 ² or 100	±2%	----	10 VDC
ORANGE	3	10 ³ or 1 K	±3%	10 ³ or 1000	±3%	----	15 VDC
YELLOW	4	10 ⁴ or 10 K	±4%	10 ⁴ or 10,000	+100% -9%	----	20 VDC
GREEN	5	10 ⁵ or 100 K	±½%	10 ⁵ or 100,000	±5%	±0.5 pF	25 VDC
BLUE	6	10 ⁶ or 1 M	±¼%	10 ⁶ or 1,000,000	----	----	35 VDC
VIOLET	7	----	±1/10%	----	----	----	50 VDC
GRAY	8	----	----	10 ⁻² or 0.01	+80% -20%	±0.25 pF	----
WHITE	9	----	----	10 ⁻¹ or 0.1	±10%	±1 pF	3 VDC
GOLD	—	10 ⁻¹ or 0.1	±5%	----	----	----	----
SILVER	—	10 ⁻² or 0.01	±10%	----	----	----	----
NONE	—	----	±20%	----	±10%	±1 pF	----

Figure 9-1. Color codes for resistors and capacitors.

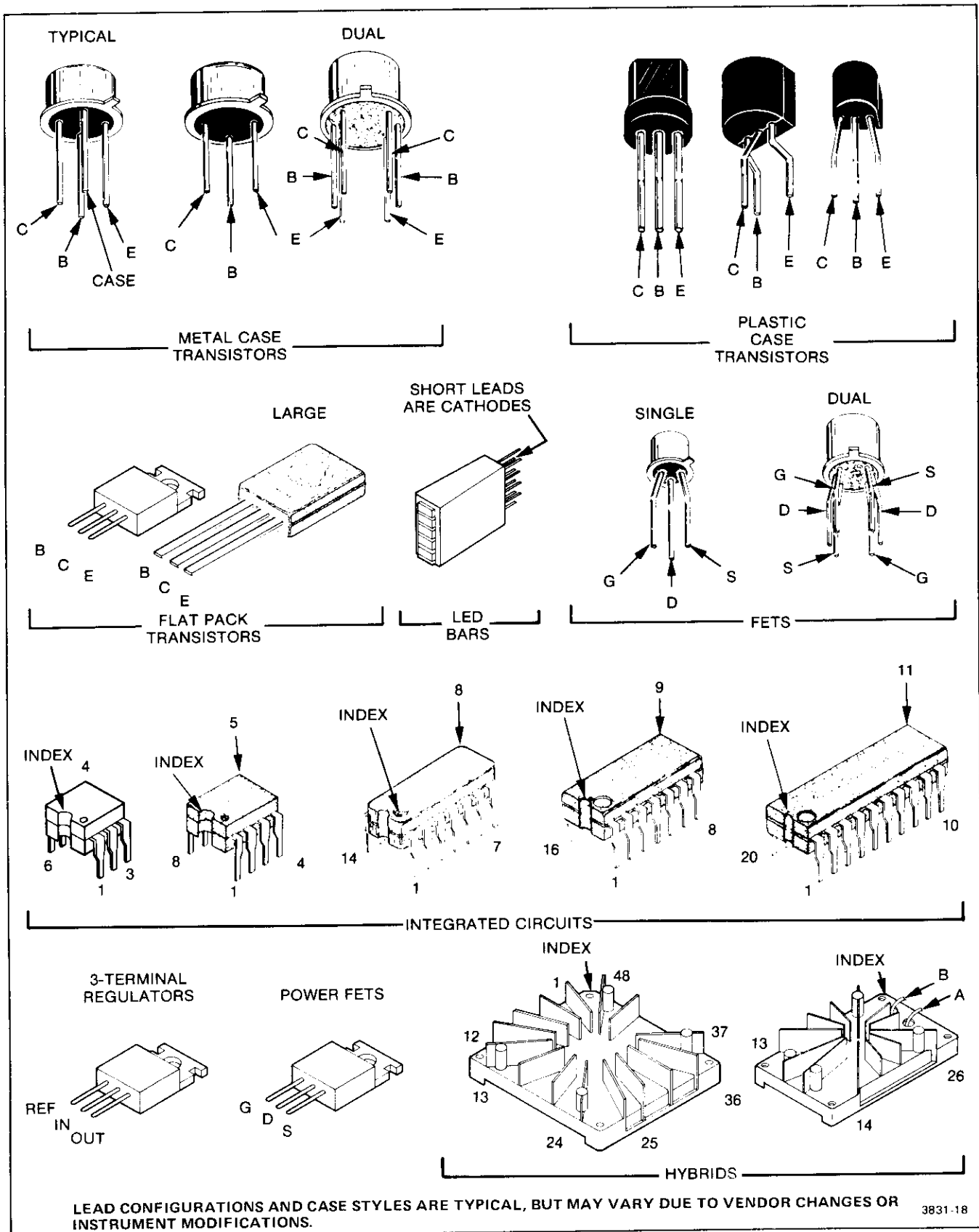

3831-18

Figure 9-2. Semiconductor lead configurations.

2445 Service

To identify any component mounted on a circuit board and to locate that component in the appropriate schematic diagram

1. Locate the Circuit Board Illustration

- a. In the instrument identify the Assembly Number of the circuit board in question. The Assembly Number is usually printed on the upper left corner of the circuit board on the component side.
- b. In the manual locate and pull out tabbed page whose title corresponds with the Assembly Number of the circuit board. Circuit board assembly numbers and board nomenclature are printed on the back side of the tabs (facing the rear of the manual).

2. Determine the Circuit Number

- a. Compare the circuit board with its illustration and locate the desired component by area and shape on the illustration.
- b. Scan the table adjacent to the Circuit Board Illustration and find the Circuit Number of the desired component.
- c. Determine the Schematic Diagram Number in which the component is located.

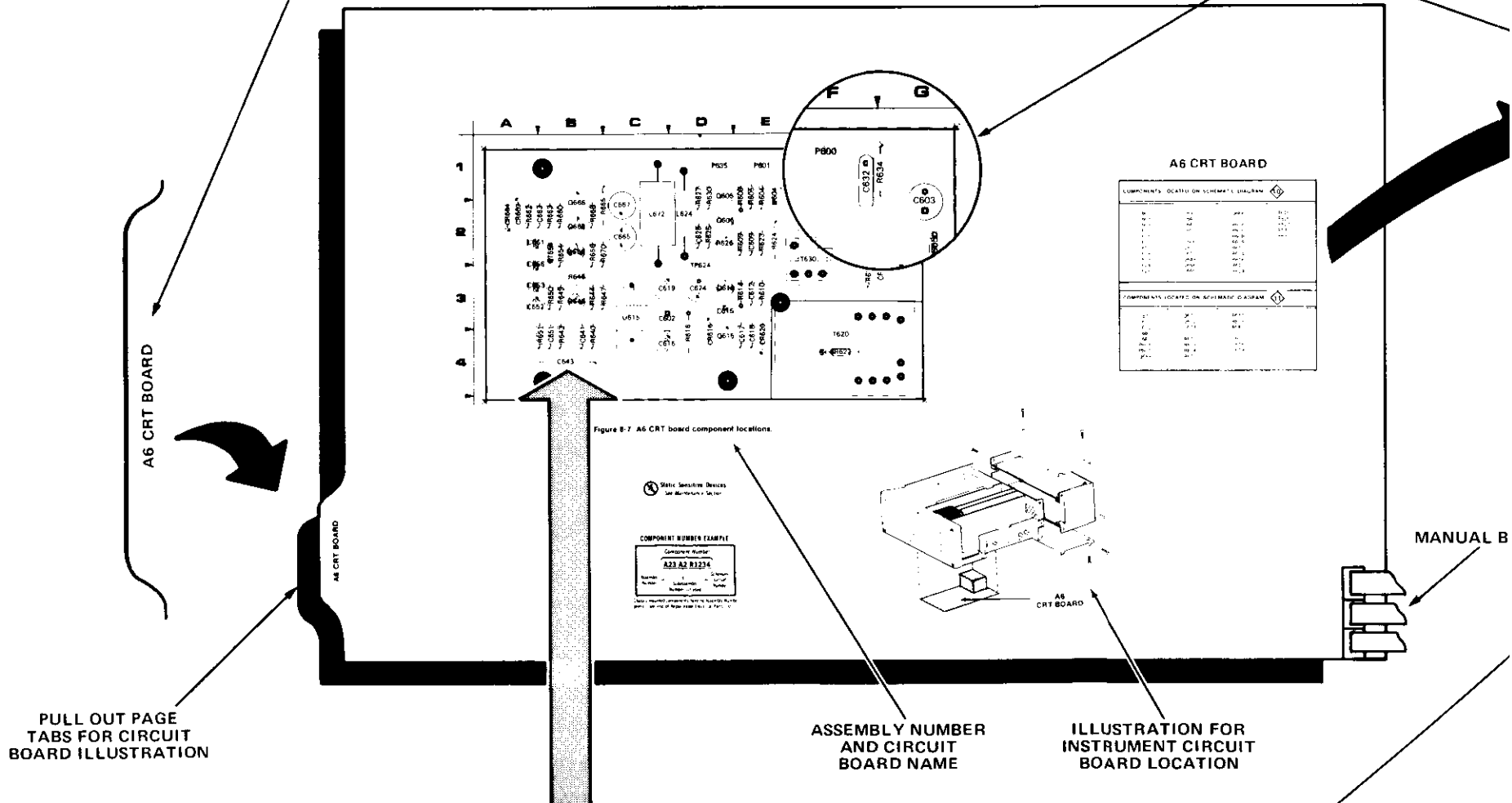

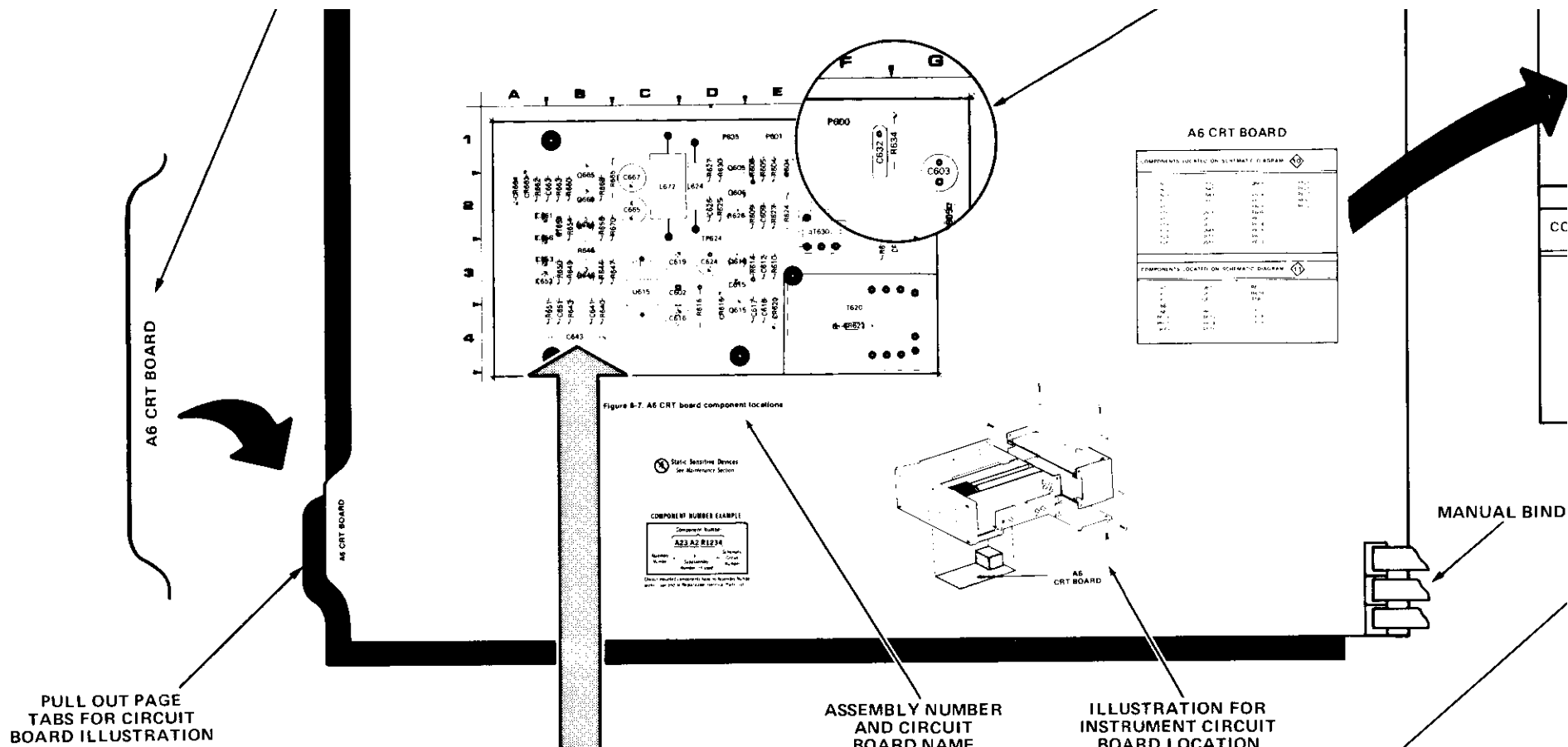

5. Locate the Component on the Circuit Board

- In the manual, locate and pull out the tabbed page whose title and Assembly Number correspond with the desired circuit board. This information is on the back side of the tabs.
- Using the Circuit Number and grid coordinates, locate the component on the Circuit Board Illustration.
- In the circuit board location illustration, determine the location of the circuit board in the instrument.
- Find the circuit board in the instrument and compare it with its illustration in the manual to locate the desired component on the board.

4. Determine the Circuit Board Illustration and Component Location

- From the schematic diagram, determine the Assembly Number of the circuit board on which the component is mounted. This information is boxed and located in a corner of the heavy line that distinguishes the board outline.
- Scan the Component Location Table for the Assembly Number just determined and find the Circuit Number of the desired component.
- Under the BOARD LOCATION column, read the grid coordinates for the desired component.

Figure 9-3. Locating components on schematic diagrams and circuit board illustrations.

CRT CIRCUIT DIAGRAM

ASSEMBLY			
CIRCUIT NUMBER	SCHEM LOCATION	BOARD LOCATION	CIRCUIT NUMBER
4C	1E	1E	4C
4D	2E	2E	4D
4E	1D	1D	4E
4F	1E	1E	4F
5U	1E	1E	5U
7B	3E	3E	7B
7C	3D	3D	7C
7D	2D	2D	7D
7E	2E	2E	7E
7F	2D	2D	7F
7G	1D	1D	7G
8A	1E	1E	8A
8B	1E	1E	8B
8C	1E	1E	8C
8D	1E	1E	8D
8E	1E	1E	8E
8F	1E	1E	8F
8G	1E	1E	8G
8H	1E	1E	8H
8I	1E	1E	8I
8J	1E	1E	8J
8K	1E	1E	8K
8L	1E	1E	8L
8M	1E	1E	8M
8N	1E	1E	8N
8O	1E	1E	8O
8P	1E	1E	8P
8Q	1E	1E	8Q
8R	1E	1E	8R
8S	1E	1E	8S
8T	1E	1E	8T
8U	1E	1E	8U
8V	1E	1E	8V
8W	1E	1E	8W
8X	1E	1E	8X
8Y	1E	1E	8Y
8Z	1E	1E	8Z

CHASSIS MOUNTED PARTS			
CIRCUIT NUMBER	SCHEM LOCATION	BOARD LOCATION	CIRCUIT NUMBER
1A	1E	1E	1A
1B	1E	1E	1B
1C	1E	1E	1C
1D	1E	1E	1D
1E	1E	1E	1E
1F	1E	1E	1F
1G	1E	1E	1G
1H	1E	1E	1H
1I	1E	1E	1I
1J	1E	1E	1J
1K	1E	1E	1K
1L	1E	1E	1L
1M	1E	1E	1M
1N	1E	1E	1N
1O	1E	1E	1O
1P	1E	1E	1P
1Q	1E	1E	1Q
1R	1E	1E	1R
1S	1E	1E	1S
1T	1E	1E	1T
1U	1E	1E	1U
1V	1E	1E	1V
1W	1E	1E	1W
1X	1E	1E	1X
1Y	1E	1E	1Y
1Z	1E	1E	1Z

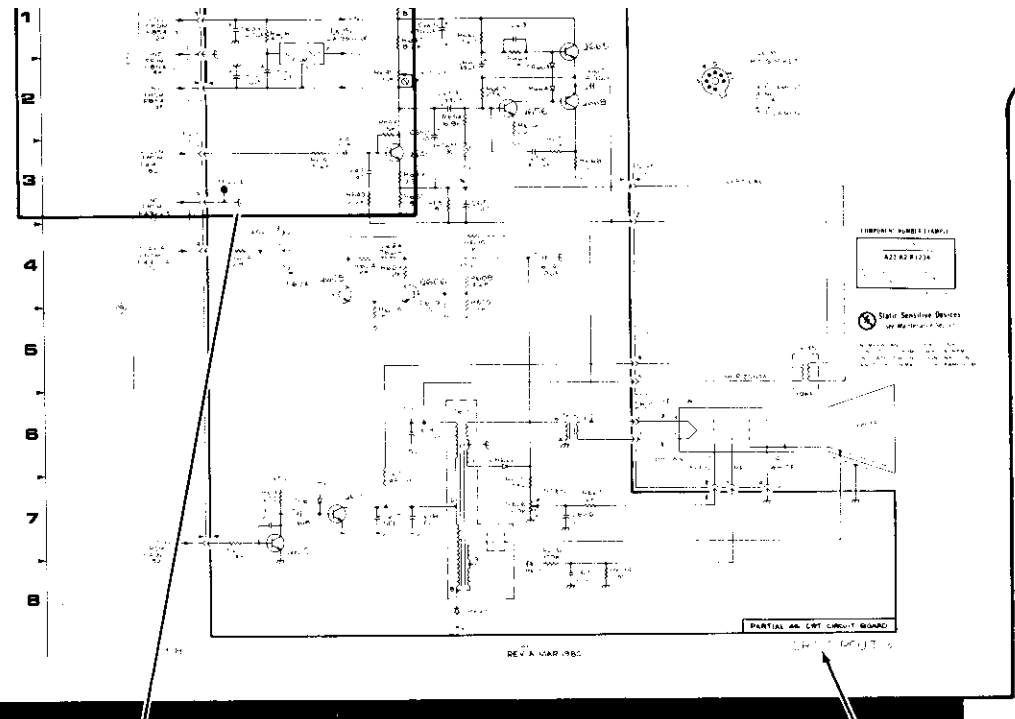

AM

SCHEM LOCATION	BOARD LOCATION
2F	2B
1G	1B
2G	2B
4C	1E
5U	1E
4E	1D
4E	2D
7B	3E
7C	3D
1C	3D
4D	2E
7F	2D
7F	2D
7G	1D
4F	1E

MANUAL BINDER

3B	2D
1D	3C

SCHEM LOCATION	BOARD LOCATION
6J	CHASSIS

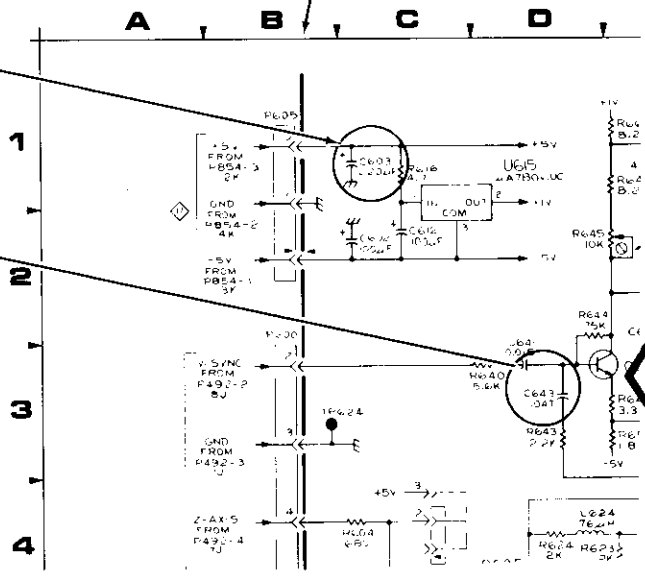

PARTIAL A6 CRT CIRCUIT BOARD
CRT CIRCUIT

To identify any component in a schematic diagram and to locate that component on its respective circuit board.

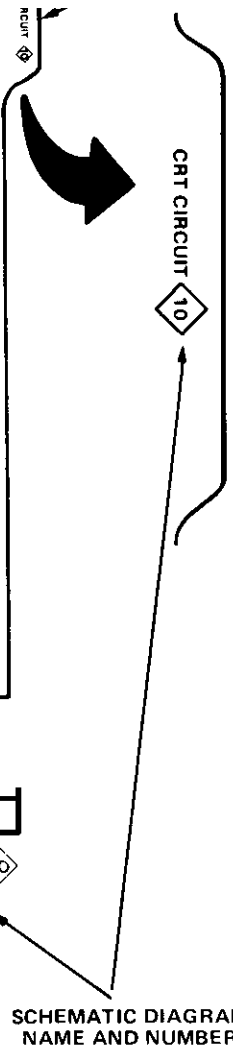

CRT CIRCUIT

SCHEMATIC DIAGRAM NAME AND NUMBER

3. Locate the Component on the Schematic Diagram

- Locate and pull out tabbed page whose number and title correspond with the Schematic Diagram Number just determined in the table. Schematic diagram nomenclature and numbers are printed on the front side of the tabs (facing the front of the manual).
- Scan the Component Location Table adjacent to the schematic diagram and find the Circuit Number of the desired component.
- Under the SCHEM LOCATION column, read the grid coordinates for the desired component.
- Using the Circuit Number and grid coordinates, locate the component on the schematic diagram.

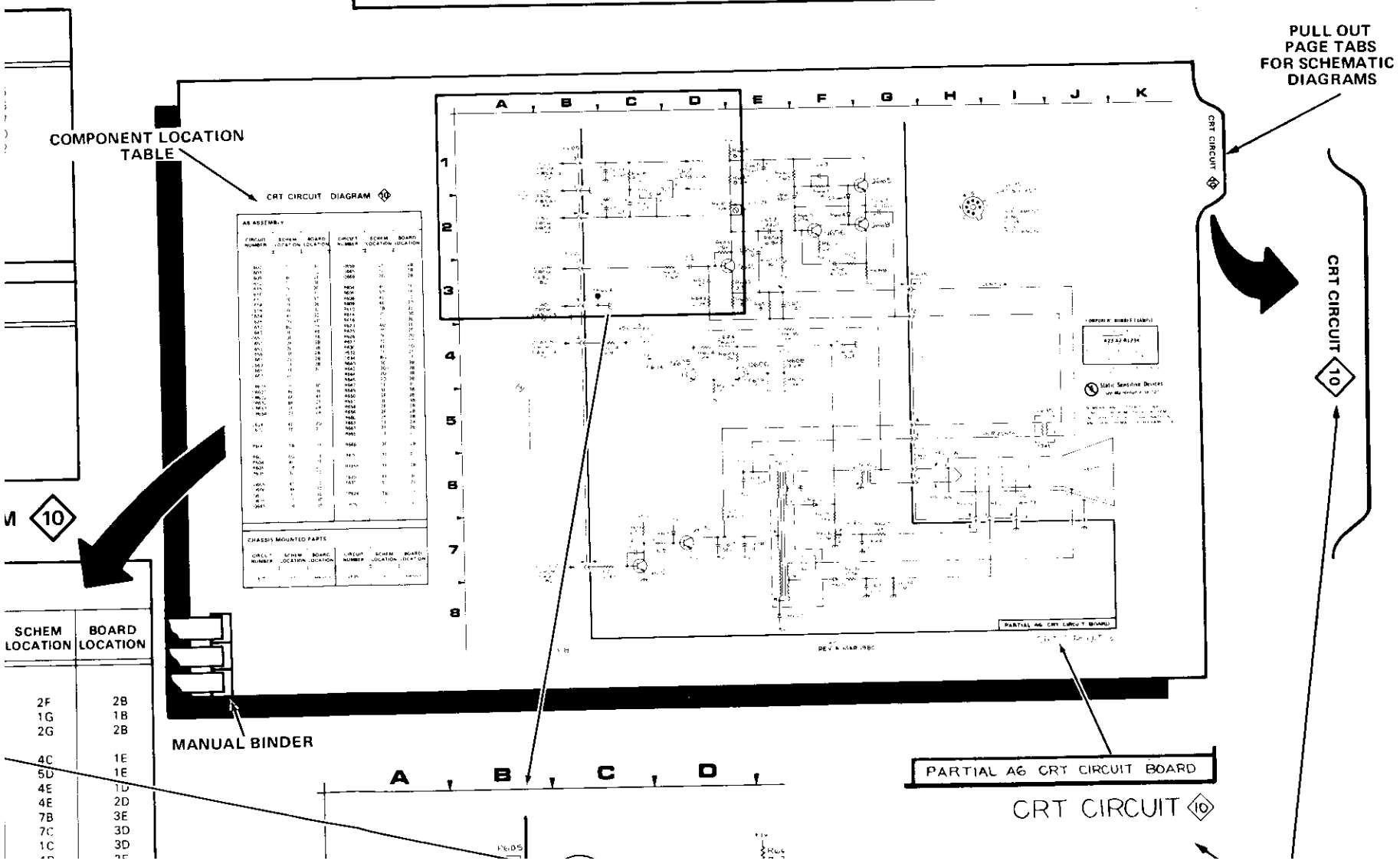

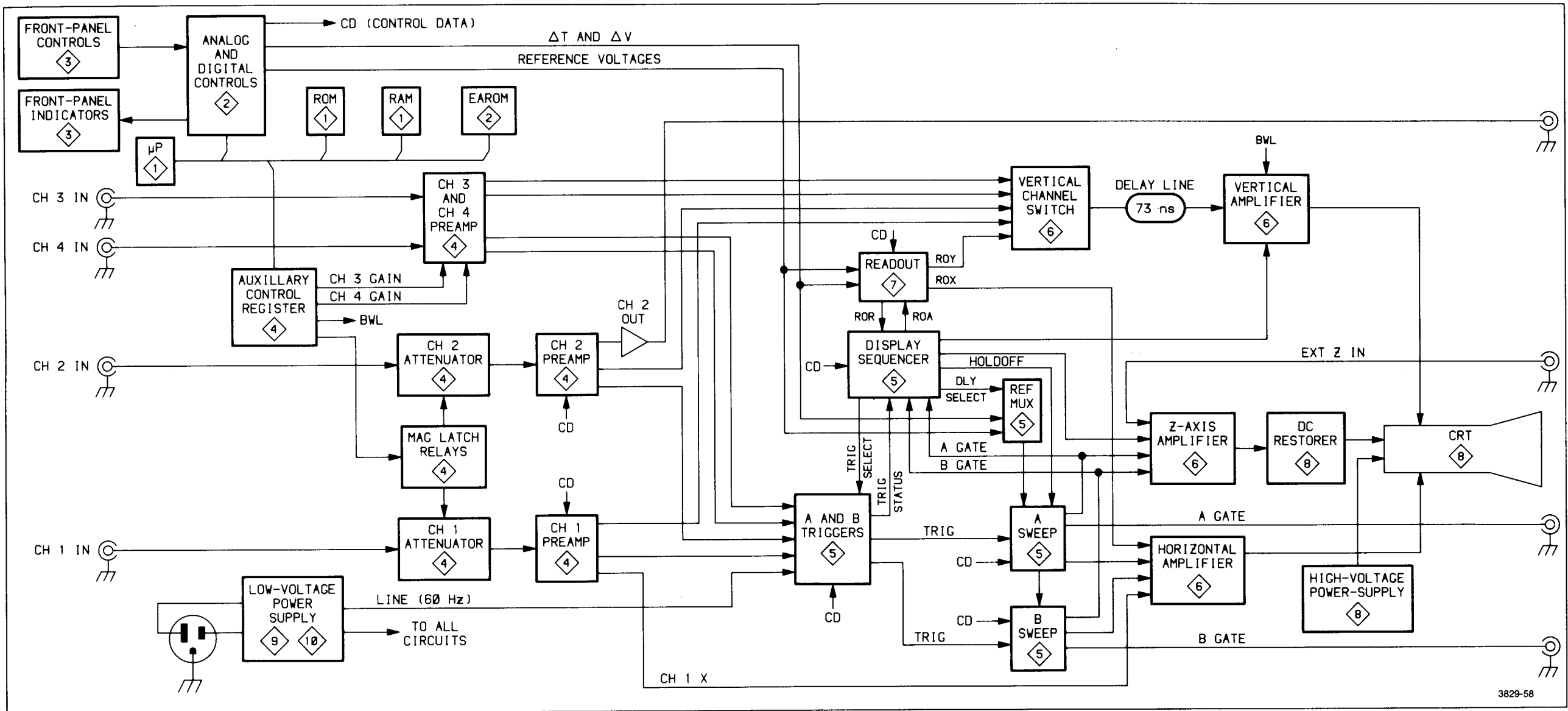
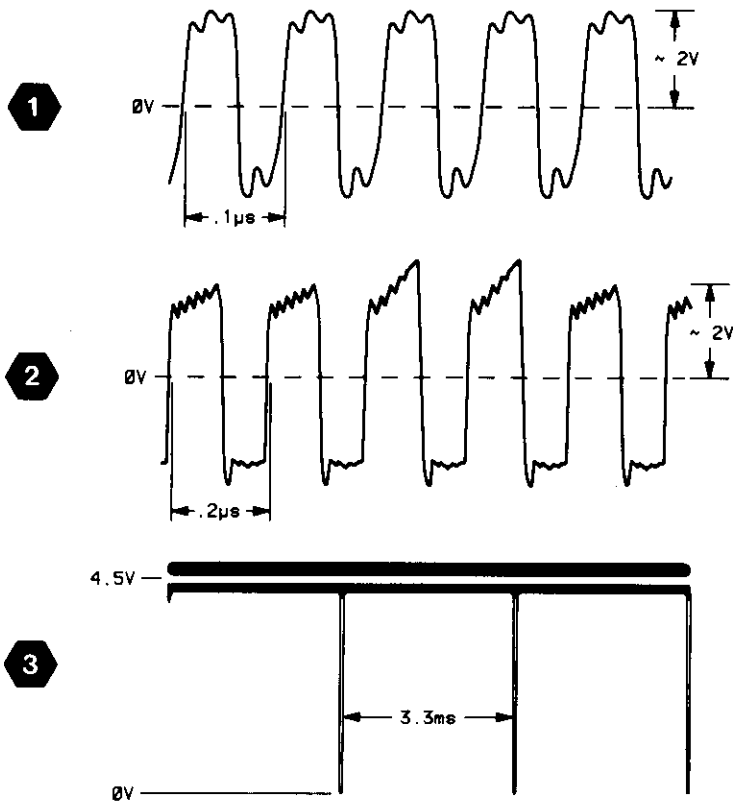

Figure 9-4. 2445 block diagram.

TEST WAVEFORM SETUP INFORMATION

The numbered waveforms below were obtained at the test points indicated on the accompanying schematic diagram and board dolly. The waveforms are representative of signals that may be expected at the associated points whenever the instrument is running.



3829-50

A5—CONTROL BOARD

CIRCUIT NUMBER	SCHEM NUMBER	CIRCUIT NUMBER	SCHEM NUMBER	CIRCUIT NUMBER	SCHEM NUMBER	CIRCUIT NUMBER	SCHEM NUMBER	CIRCUIT NUMBER	SCHEM NUMBER
C2041	12	P503	1	R2317	2	R2614	2	U2362	1
C2188	12	P511	2	R2319	2	R2645	1	U2362	12
C2203	1	P511	2	R2320	2	R2646	1	U2378	1
C2217	12	P511	2	R2324	2	R2647	1	U2378	12
C2218	12	P511	12	R2325	2	R2648	1	U2408	2
C2221	12	P512	1	R2330	2	R2649	1	U2408	12
C2222	2	P512	2	R2340	2	R2650	1	U2418	2
C2223	12	P512	2	R2341	2	R2652	1	U2418	12
C2224	2	P512	2	R2342	2	R2662	1	U2427	2
C2240	12	P512	12	R2343	2	R2663	1	U2427	2
C2318	2	Q2025	2	R2344	2	R2703	2	U2427	2
C2326	2	Q2322	2	R2345	2	R2730	2	U2427	2
C2327	2	R2012	2	R2444	2	R2731	2	U2427	12
C2328	12	R2013	2	R2445	2	R2732	2	U2435	1
C2329	2	R2014	2	R2446	2	R2734	2	U2435	2
C2330	2	R2015	2	R2447	2	R2735	2	U2435	2
C2346	12	R2016	2	R2448	2	R2741	2	U2435	2
C2354	12	R2017	2	R2449	2	R2742	2	U2435	12
C2440	12	R2018	2	R2450	2	R2745	2	U2456	2
C2441	2	R2019	2	R2451	2	R2764	1	U2456	12
C2443	2	R2020	2	R2452	2	TP503	2	U2468	1
C2475	12	R2022	2	R2463	1	TP504	2	U2468	1
C2485	12	R2023	2	R2504	2	TP505	1	U2468	12
C2486	1	R2025	2	R2505	2	TP506	1	U2480	1
C2524	2	R2028	2	R2506	2	TP507	1	U2480	12
C2527	12	R2029	2	R2507	2	TP508	12	U2496	1
C2530	2	R2040	2	R2508	2	TP509	1	U2496	12
C2536	2	R2103	2	R2509	2	TP510	1	U2556	1
C2540	2	R2113	2	R2510	2	TP511	1	U2556	1
C2542	2	R2123	2	R2511	2	U2008	2	U2556	1
C2550	1	R2127	2	R2512	2	U2008	2	U2556	1
C2565	1	R2140	2	R2513	2	U2034	2	U2556	1
C2566	1	R2141	2	R2514	2	U2034	12	U2556	1
C2572	1	R2142	2	R2515	2	U2092	1	U2556	12
C2575	12	R2143	2	R2516	2	U2092	12	U2580	1
C2586	12	R2144	2	R2517	2	U2108	2	U2580	12
C2637	12	R2145	2	R2518	2	U2108	12	U2596	1
C2638	2	R2162	1	R2519	2	U2118	1	U2596	12
C2640	2	R2185	1	R2520	2	U2118	2	U2634	2
C2642	12	R2186	1	R2521	2	U2118	2	U2634	2
C2661	1	R2187	1	R2522	2	U2118	2	U2634	12
C2734	12	R2224	2	R2525	2	U2118	2	U2656	1
CR2004	2	R2227	2	R2532	2	U2118	2	U2656	1
CR2021	2	R2228	2	R2534	2	U2118	2	U2656	1
CR2122	2	R2229	2	R2535	2	U2118	2	U2656	1
CR2651	1	R2230	2	R2539	2	U2134	2	U2656	12
CR2723	2	R2241	2	R2540	2	U2134	12	U2668	1
CR2731	2	R2242	2	R2541	2	U2162	1	U2668	12
CR2733	2	R2243	2	R2542	2	U2162	12	U2770	1
CR2742	2	R2244	2	R2543	2	U2178	1	U2770	12
CR2744	2	R2245	2	R2545	2	U2178	12	VR2003	2
J251	1	R2246	2	R2546	2	U2194	1	VR2526	2
J251	12	R2252	1	R2547	2	U2194	1	W511	2
J500	1	R2285	1	R2549	1	U2208	1	W511	2
J500	1	R2286	1	R2551	1	U2208	2	W511	2
J500	1	R2287	1	R2553	1	U2214	2	W511	12
J501	2	R2288	1	R2564	1	U2214	12	W512	1
J502	2	R2297	1	R2571	1	U2234	2	W512	2
J503	1	R2298	1	R2573	1	U2234	1	W512	2
J651	2	R2299	1	R2608	12	U2294	12	W512	2
J651	2	R2303	2	R2609	2	U2294	1	W512	12
J651	2	R2312	2	R2610	2	U2308	2	W2143	12
J652	2	R2313	2	R2611	2	U2308	12	W2526	12
J652	2	R2314	2	R2612	2	U2335	2	Y2568	1
P501	2	R2315	2	R2613	2	U2335	12		
		R2316	2						

PROCESSOR AND DIGITAL CONTROL DIAGRAM



ASSEMBLY A5								
CIRCUIT NUMBER	SCHEM LOCATION	BOARD LOCATION	CIRCUIT NUMBER	SCHEM LOCATION	BOARD LOCATION	CIRCUIT NUMBER	SCHEM LOCATION	BOARD LOCATION
C2203	6C	2D	R2299	9A	3H	U2194	7B	2H
C2486	6C	2H	R2463	4C	4J	U2194	9C	2H
C2550	6C	3G	R2549	4C	4J	U2208	7C	2E
C2565	4C	4H	R2551	5N	3E	U2294	7B	3H
C2566	4B	4H	R2553	4B	4H	U2294	9D	3H
C2572	3B	4H	R2564	4C	4H	U2362	8H	3J
C2661	6A	4F	R2571	3B	4J	U2378	8F	2J
CR2651	6B	4F	R2573	3B	4J	U2435C	6B	3E
			R2645	5D	4F	U2468A	4D	4J
			R2646	5B	4F	U2468B	2E	4J
J251	5A	2D	R2647	5B	4F	U2480	5G	4K
J500	1P	2E	R2648	5B	3F	U2496	8K	3K
J500	4A	2E	R2649	5C	3F	U2556A	4B	3J
J500	8P	2E	R2650	6C	4F	U2556B	4C	3J
J503	6B	3G	R2652	5A	3F	U2556C	4F	3J
			R2662	6P	4F	U2556D	3B	3J
P503	6B	3G	R2663	4G	4J	U2556E	3H	3J
P512	4P	4H	R2764	3D	4K	U2556F	3F	3J
						U2580	4K	4J
R2162	6H	1K	TP505	4E	1G	U2596	5M	3K
R2185	4B	1F	TP506	5G	4K	U2656A	6C	4G
R2186	5D	1F	TP507	5H	4K	U2656B	5N	4G
R2187	9B	3G	TP509	5H	4K	U2656C	3G	4G
R2252	7B	3F	TP510	5H	4K	U2656D	5N	4G
R2285	8A	3G	TP511	5H	4K	U2668	3H	4G
R2286	9A	3H				U2770	4H	3J
R2287	9B	3H	U2092	5D	1G			
R2288	8B	3H	U2118A	7B	3E	W512	7P	4H
R2297	9B	3H	U2162	6H	2K			
R2298	8A	3H	U2178	6F	1J	Y2568	4B	4H

Partial A5 also shown on diagrams 2 and 12.

ACRONYM DICTIONARY

The following listing explains some of the less obvious acronyms and signal labels used on this schematic. Acronyms and labels not shown in this listing may be included in the circuit descriptions (Section 3) and should be obvious if a little thought is given to the intended circuit function.

- | | |
|--|---|
| ATTN CLK . . . attenuator clock | MR . . . memory ready |
| A0 – A15 . . . address bits 0 – 15 | NMI . . . non-maskable interrupt |
| A000H . . . address block A000 hex | PORT 3 INH . . . port 3 inhibit |
| BA . . . bus available | RE . . . RAM enable |
| BD0 – BD7 . . . buffered data bits 0 – 7 | ROSFAME . . . readout subframe |
| C000H . . . address block C000 hex | ROS1 (900H) . . . readout strobe 1 (address 0900 hex) |
| DAC MUX0 INH . . . DAC multiplexer 0 inhibit | ROS2 (940H) . . . readout strobe 2 (address 0940 hex) |
| DAC MUX1 INH . . . DAC multiplexer 1 inhibit | R/W . . . read/write |
| D0 – D7 . . . data bits 0 – 7 | R/W DLY'D . . . read/write delayed |
| E . . . enable | TRIG STAT STRB . . . trigger status strobe |
| \bar{E} . . . enable | VMA . . . valid memory address |
| EXTAL . . . external crystal | XTAL . . . crystal |
| E000H . . . address block E000 hex | 0000H . . . address block 0000 hex |
| GND C . . . virtual ground "C" | 8000H . . . address block 8000 hex |
| IRQ . . . interrupt request | 9C1H – 9CFH . . . addresses 09C1 hex – 09CF hex |
| LED CLK . . . LED clock | |



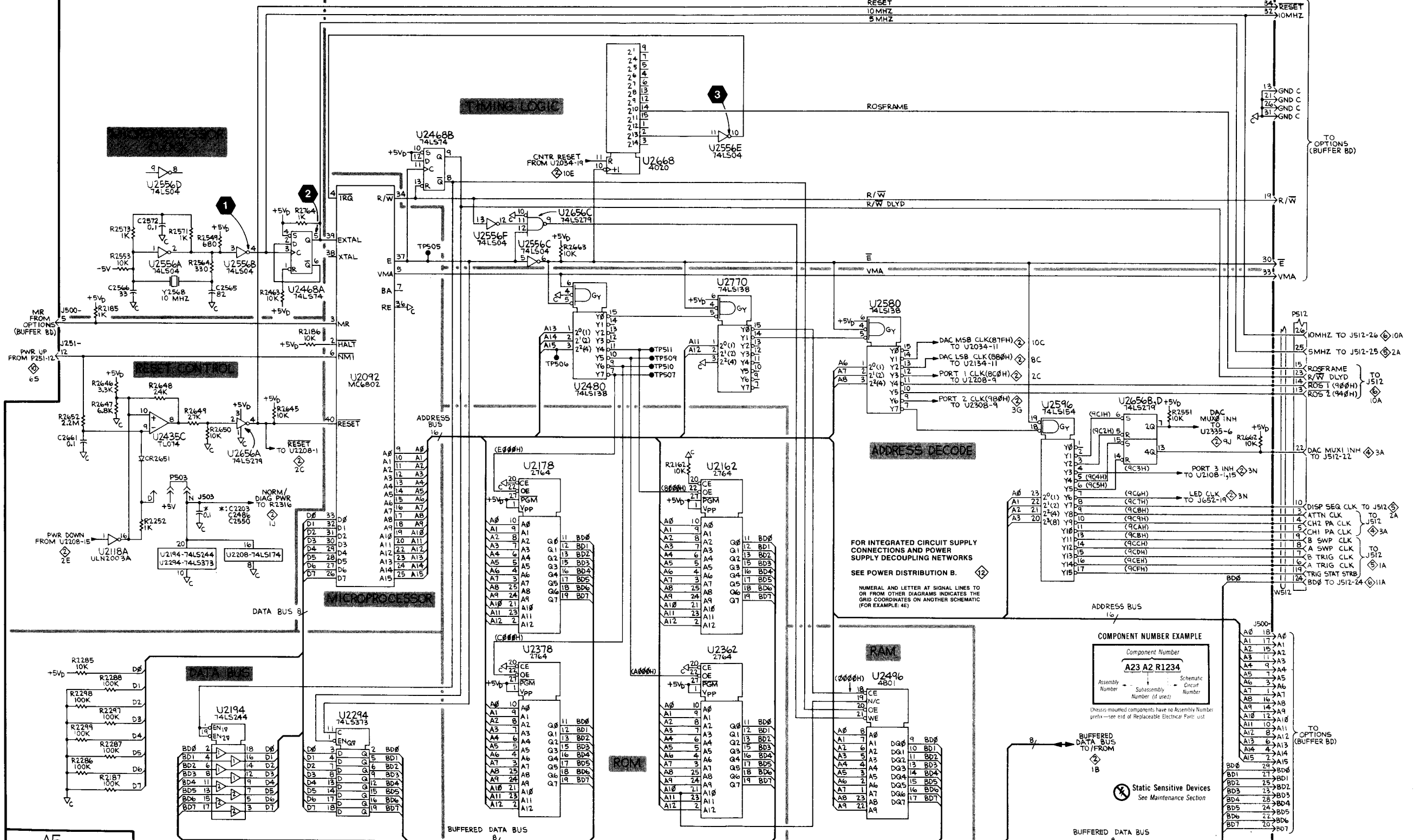

TEST WAVEFORM SETUP INFORMATION

The waveform below was obtained at the test point indicated on the accompanying schematic diagram. The waveform is representative of the signal that may be expected at the test point whenever the instrument is running.

Also shown below is an illustration depicting timing of the D to A Converter and the output ranges that may be expected as the DAC sets up the various analog reference voltages. Test point locations and setup information are called out on the illustration.

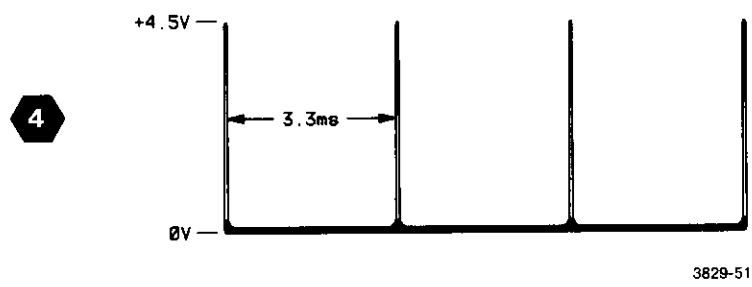

3829-51

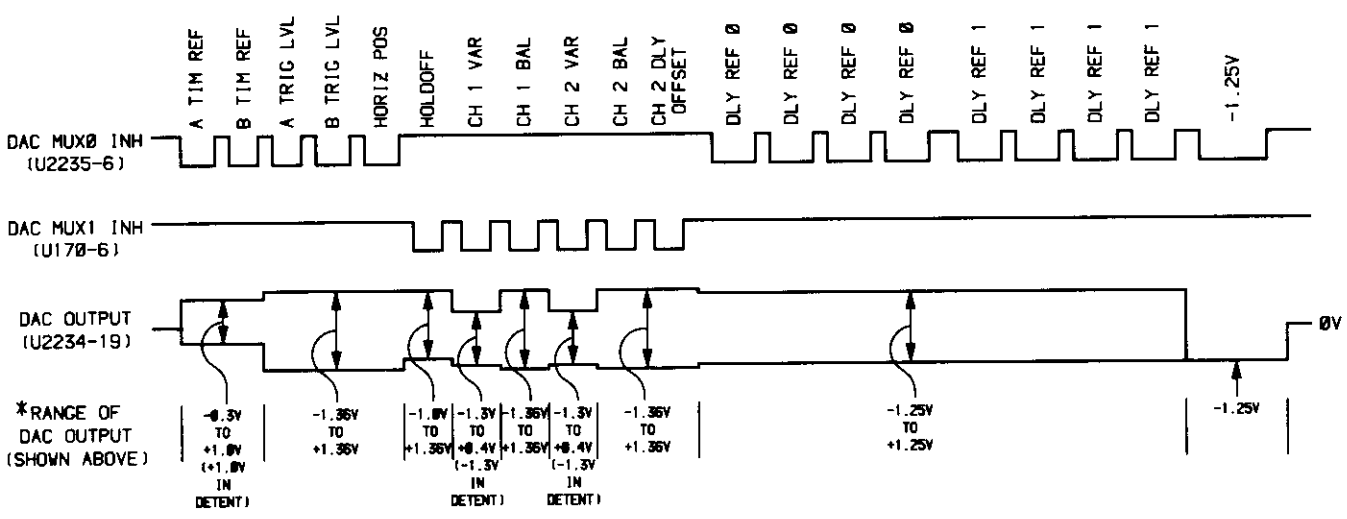

*NOTE: AS ANY GIVEN CONTROL IS EXERCISED, THE CORRESPONDING PORTION OF THE DAC OUTPUT WAVEFORM SHOULD VARY WITHIN THE LIMITS INDICATED.

3831-19

ANALOG CONTROL DIAGRAM



ASSEMBLY A5											
CIRCUIT NUMBER	SCHEM LOCATION	BOARD LOCATION	CIRCUIT NUMBER	SCHEM LOCATION	BOARD LOCATION	CIRCUIT NUMBER	SCHEM LOCATION	BOARD LOCATION	CIRCUIT NUMBER	SCHEM LOCATION	BOARD LOCATION
C2222	8H	2C	R2016	2L	3G	R2444	5F	4B	R2732	9N	4E
C2224	8H	1C	R2017	2K	3F	R2445	5G	2A	R2734	9N	4F
C2318	4J	2D	R2018	3K	3F	R2446	5F	2A	R2735	9M	4E
C2326	5P	3D	R2019	2L	3G	R2447	6F	4C	R2741	9M	4F
C2327	8M	4E	R2020	3K	4G	R2448	6G	3B	R2742	10M	4F
C2329	8L	4E	R2022	2K	4G	R2449	6G	3A	R2745	10L	4F
C2330	6K	4D	R2023	2N	3G	R2450	6H	3B			
C2441	6L	3D	R2025*	2N	3G	R2451	6H	3B	TP503	5P	3B
C2443	7N	4D	R2028	3L	3F	R2452	6H	3B	TP504	6P	4C
C2524	5N	3C	R2029	2N	3G	R2504	3E	4A			
C2530	6L	4C	R2040	10C	2B	R2505	2D	4B	U2008	2N	3G
C2536	8N	4F	R2103	4K	2E	R2506	3D	4A	U2008	3N	3G
C2540	9L	4E	R2113	2P	2E	R2507	3E	4A	U2034	9D	2B
C2542	9L	4E	R2123	2N	4F	R2508	3E	4B	U2108	2P	2G
C2638	9L	3E	R2127	8H	2C	R2509	3D	4B	U2188	2K	3E
C2640	9K	4D	R2127	8H	2C	R2510	3E	4B	U218C	3K	3E
			R2140	8G	2B	R2511	3D	4A	U218D	2K	3E
			R2141	8D	2A	R2512	5E	4C	U218E	2K	3E
CR2004	1K	4G	R2142	8D	1B	R2513	4D	4C	U218F	3K	3E
CR2021	3K	4G	R2143	8G	1A	R2514	4D	4C	U218G	2N	3E
CR2122	2P	3G	R2144	8E	2A	R2515	5D	4B	U2118	1L	3E
CR2723	5P	3A	R2145	8E	2A	R2516	5E	4C	U2134	8D	1B
CR2731	9M	4E	R2224	6G	4C	R2517	5E	4B	U2208	2D	2E
CR2733	9N	4E	R2227	8H	2C	R2518	5E	4B	U2214	5K	2D
CR2742	9M	4E	R2228	7H	2C	R2519	5D	4B	U2234	7J	2B
CR2744	9L	4E	R2229	7H	2C	R2520	5D	4B	U2308	3H	2F
			R2230	7G	2C	R2521	5D	4B	U2335	8K	3D
J501	7H	3B	R2241	8E	2B	R2522	5N	3C	U2408	4F	3A
J502	2M	2G	R2242	8E	1A	R2525	5N	4D	U2418	5F	3B
J651	2B	3A	R2243	8F	1A	R2532	7N	4E	U2427A	6M	3C
J651	5P	3A	R2244	8F	1B	R2534	7N	4E	U2427B	6L	3C
J651	8B	3A	R2245	8F	1C	R2535	8N	4E	U2427C	7N	3C
J652	3P	2A	R2246	8G	2A	R2539	8N	4E	U2427D	5N	3C
J652	5B	2A	R2303	4G	2F	R2540	7L	4D	U2435A	9M	3E
			R2312	2F	3D	R2541	7L	4D	U2435B	9L	3E
P501	7G	3B	R2313	4F	3D	R2542	9L	4E	U2435D	8N	3E
P511	4A	4C	R2314	2J	3C	R2543	9L	4E	U2456	5J	3B
P511	6S	4C	R2315	2J	3C	R2545	5G	2A	U2634A	7M	4D
P511	9A	4C	R2316	2J	3C	R2546	5H	2A	U2634B	8L	4D
P512	10S	4H	R2317	4J	3D	R2547	5H	2B			
P512	1A	4H	R2319	4J	2D	R2609	3D	4B	VR2003	1K	4F
P512	4S	4H	R2320	5J	2D	R2610	3D	4B	VR2526	6N	4A
			R2324	6K	3C	R2611	3D	4B			
Q2025	2N	3G	R2325	5J	3C	R2612	3E	4B	W511	10B	4C
Q2322	5P	3D	R2330	6L	4C	R2613	5D	4B	W511	5B	4C
			R2340	10N	2E	R2614	5E	4B	W511	9P	4C
R2012	2L	3F	R2341	10P	3E	R2703	5P	4B	W512	10P	4H
R2013	2K	3F	R2342	10N	3D	R2730	8M	4D	W512	1B	4H
R2014	3K	3F	R2343	10P	3E	R2731	8L	4D	W512	5P	4H
R2015	2L	3F	R2344	10N	3E						
			R2345	10P	3E						

Partial A5 also shown on diagrams 1 and 12.

*See Parts List for serial number ranges.

ACRONYM DICTIONARY

The following listing explains some of the less obvious acronyms and signal labels used on this schematic. Acronyms and labels not shown in this listing may be included in the circuit descriptions (Section 3) and should be obvious if a little thought is given to the intended circuit function.

- A TIM REF . . . A timing reference
- ATTN STRB . . . attenuator strobe
- BD0 – BD7 . . . buffered data bits 0 – 7
- B TIM REF . . . B timing reference
- CH1 OVL . . . channel 1 overload
- CH2 OVL . . . channel 2 overload
- CH1 PRB . . . channel 1 probe
- CH2 PRB . . . channel 2 probe
- CH3 PRB . . . channel 3 probe
- CH4 PRB . . . channel 4 probe

- CONT DATA . . . control data
- DAC MUX0 INH . . . DAC multiplexer 0 inhibit
- DAC MUX1 A0 . . . DAC multiplexer 1, address bit 0
- DAC MUX1 A1 . . . DAC multiplexer 1, address bit 1
- DAC MUX1 A2 . . . DAC multiplexer 1, address bit 2
- DAC MUX1 IN . . . DAC multiplexer input
- GND C . . . virtual ground "C"
- OEA35 . . . option EAROM +35 volt
- OEACLK . . . option EAROM clock
- OEAI/O . . . option EAROM input/output
- OEAC1 . . . option EAROM mode code, bit 1
- OEAC2 . . . option EAROM mode code, bit 2
- OEAC3 . . . option EAROM mode code, bit 3
- PORT 3 INH (9C3H) . . . port 3 inhibit
- RO DO . . . readout data out
- RO ON . . . readout on
- SI . . . scope identification
- TSO . . . trigger status output

ANALOG CONTROL



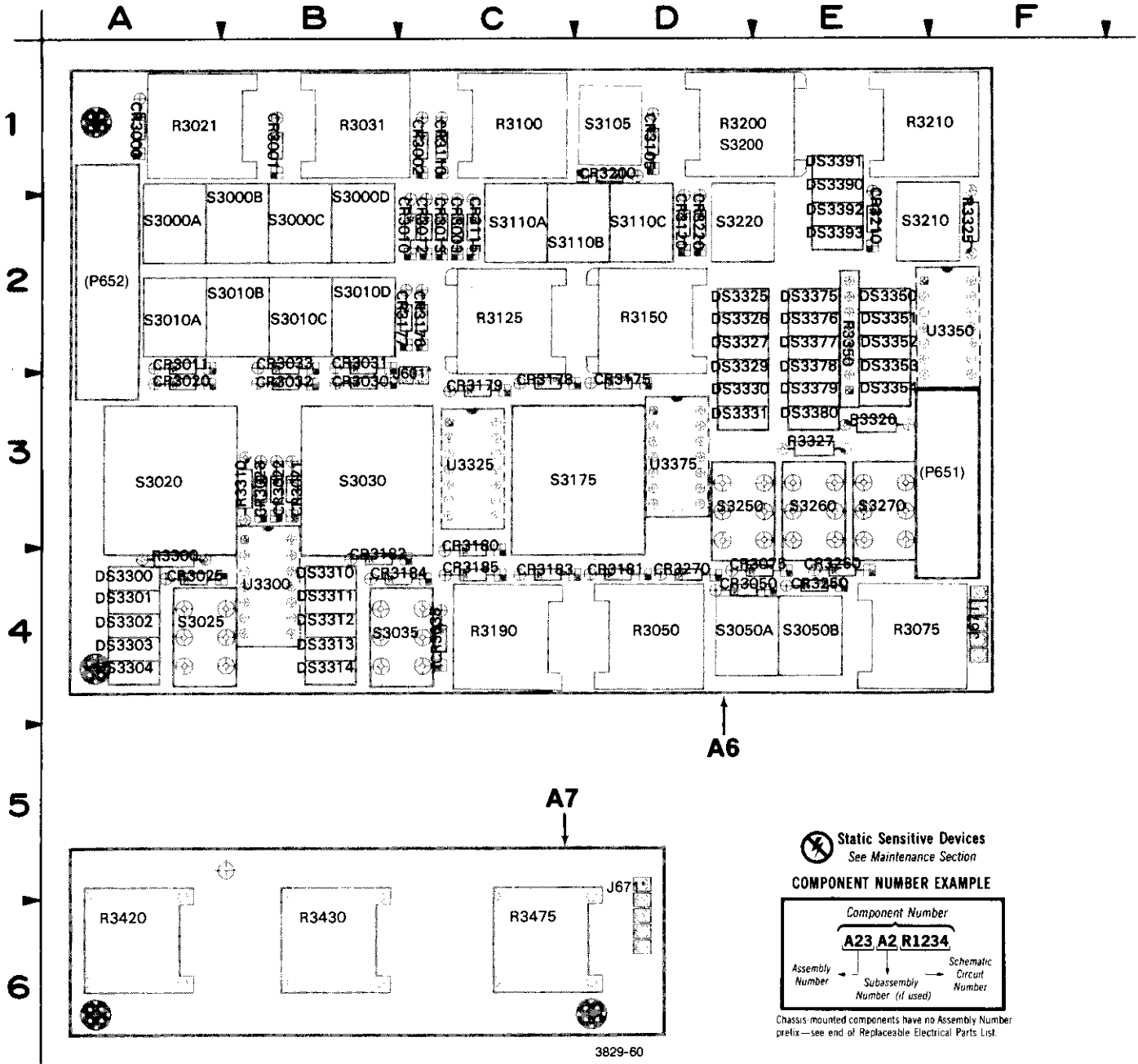

Figure 9-6. A6—Front Panel and A7—Front Panel Variable boards.

* LABELED ON SOME BOARDS AS "P" VICE "J".

() COMPONENTS WITHIN PARENTHESES MAY NOT BE LOCATED PRECISELY AS SHOWN BUT ARE NEAR THEIR INDICATED POSITION.

ALL COMPONENTS MOUNTED ON A7—FRONT PANEL VARIABLE CIRCUIT BOARD ARE SHOWN ON SCHEMATIC

A6—FRONT PANEL BOARD

CIRCUIT NUMBER	SCHEM NUMBER	CIRCUIT NUMBER	SCHEM NUMBER	CIRCUIT NUMBER	SCHEM NUMBER	CIRCUIT NUMBER	SCHEM NUMBER
CR3000	3	CR3200	3	DS3392	3	S3010	3
CR3001	3	CR3210	3	DS3393	3	S3010	3
CR3002	3	CR3220	3	J601	3	S3010	3
CR3003	3	CR3250	3	J671	3	S3010	3
CR3010	3	CR3260	3	P651	3	S3020	3
CR3011	3	CR3270	3	P651	12	S3025	3
CR3012	3	DS3300	3	P652	3	S3030	3
CR3013	3	DS3301	3	P652	3	S3035	3
CR3020	3	DS3302	3	P652	12	S3050	3
CR3021	3	DS3303	3	R3021	3	S3050	3
CR3022	3	DS3304	3	R3031	3	S3105	3
CR3023	3	DS3310	3	R3050	3	S3110	3
CR3025	3	DS3311	3	R3075	3	S3110	3
CR3030	3	DS3312	3	R3100	3	S3110	3
CR3031	3	DS3313	3	R3125	3	S3175	3
CR3032	3	DS3314	3	R3150	3	S3175	3
CR3033	3	DS3325	3	R3190	3	S3200	3
CR3035	3	DS3326	3	R3200	3	S3210	3
CR3050	3	DS3327	3	R3210	3	S3220	3
CR3075	3	DS3329	3	R3300	3	S3250	3
CR3105	3	DS3330	3	R3310	3	S3260	3
CR3110	3	DS3331	3	R3325	3	S3270	3
CR3115	3	DS3350	3	R3326	3	U3300	3
CR3120	3	DS3351	3	R3327	3	U3300	12
CR3175	3	DS3352	3	R3350	3	U3325	3
CR3176	3	DS3353	3	R3350	3	U3325	12
CR3177	3	DS3354	3	R3350	3	U3350	3
CR3178	3	DS3375	3	R3350	3	U3350	12
CR3179	3	DS3376	3	R3350	3	U3375	3
CR3180	3	DS3377	3	R3350	3	U3375	12
CR3181	3	DS3378	3	R3350	3	W651	3
CR3182	3	DS3379	3	S3000	3	W651	12
CR3183	3	DS3380	3	S3000	3	W652	3
CR3184	3	DS3390	3	S3000	3	W652	3
CR3185	3	DS3391	3	S3000	3	W652	12

1
2
3
4

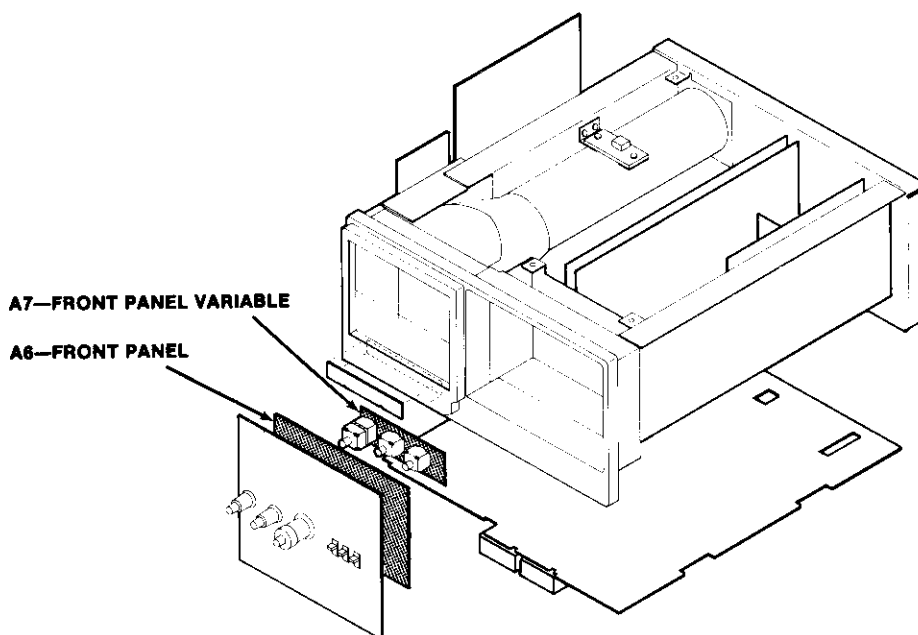

F E D C B A

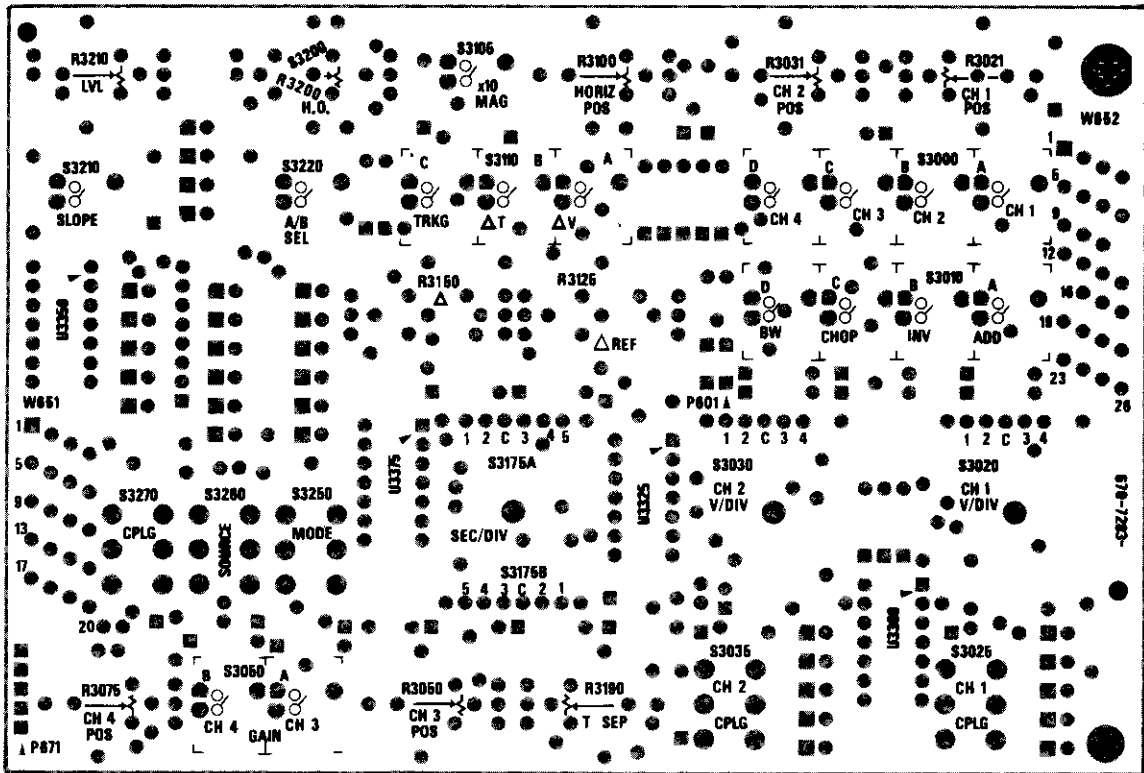

3829-61

Figure 9-7. Circuit view of A6—Front Panel.

 Static Sensitive Devices
See Maintenance Section

COMPONENT NUMBER EXAMPLE

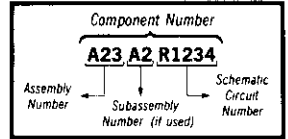

Chassis-mounted components have no Assembly Number prefix—see end of Replaceable Electrical Parts List.

FRONT PANEL CONTROLS DIAGRAM

3

ASSEMBLY A6											
CIRCUIT NUMBER	SCHEM LOCATION	BOARD LOCATION	CIRCUIT NUMBER	SCHEM LOCATION	BOARD LOCATION	CIRCUIT NUMBER	SCHEM LOCATION	BOARD LOCATION	CIRCUIT NUMBER	SCHEM LOCATION	BOARD LOCATION
CR03000	2J	1A	CR3200	3J	1D	DS3391	10P	1E	S3000B	3K	2B
CR3001	2K	1B	CR3210	4N	2E	DS3392	8L	2E	S3000C	3M	2B
CR3002	2M	1C	CR3220	5L	2D	DS3393	7F	2E	S3000D	3N	2B
CR3003	2N	2C	CR3250	5K	4E				S3010A	3L	2A
CR3010	2L	2C	CR3260	6J	4E	J601	5D	3C	S3010B	3D	2B
CR3011	3D	2A	CR3270	2B	4D	J671	7P	4F	S3010C	3K	2B
CR3012	3K	2C							S3010D	3L	2B
CR3013	3L	2C	DS3300	6B	4A	P651	3S	3F	S3020	3D	3A
CR3020	3B	3A	DS3301	6C	4A	P652	1S	2A	S3025	1B	4A
CR3021	3B	3B	DS3302	6C	4A	P652	7A	2A	S3030	4D	3B
CR3022	3B	3B	DS3303	7C	4A				S3035	2C	4B
CR3023	3C	3B	DS3304	7D	4A	R3021	3P	1A	S3050A	2B	4D
CR3025	2C	4A	DS3310	7D	4B	R3031	4P	1B	S3050B	2A	4E
CR3030	5B	3B	DS3311	7E	4B	R3050	4P	4D	S3105	4J	1D
CR3031	5B	2B	DS3312	7E	4B	R3075	5P	4E	S3110A	4M	2C
CR3032	5B	3B	DS3313	7E	4B	R3100	5P	1C	S3110B	4L	2C
CR3033	5C	2B	DS3314	7F	4B	R3125	5P	2C	S3110C	4K	2D
CR3035	2C	4C	DS3325	8H	2D	R3150	6P	2D	S3175A	3H	3C
CR3050	2C	4D	DS3326	8H	2D	R3190	3P	4C	S3175B	5H	3C
CR3075	2B	4D	DS3327	8G	2D	R3200	6P	1D	S3200	3J	1D
CR3105	4J	1D	DS3329	7G	2D	R3210	6P	1E	S3210	4N	2E
CR3110	4M	1C	DS3330	8J	3D	R3300	6D	4A	S3220	5L	2D
CR3115	4L	2C	DS3331	8J	3D	R3310	7F	3B	S3250	5K	3D
CR3120	4K	2D	DS3350	8J	2E	R3325	8L	2F	S3260	5J	3E
CR3175	2F	3D	DS3351	8K	2E	R3326	9N	3E	S3270	1A	3E
CR3176	2F	2C	DS3352	8K	2E	R3327	9P	3E			
CR3177	2F	2C	DS3353	8L	2E	R3350A	9N	2E	U3300	8B	4B
CR3178	2G	3C	DS3354	8L	3E	R3350B	9M	2E	U3325	9E	3C
CR3179	2G	3C	DS3375	9M	2E	R3350C	8M	2E	U3350	9H	2F
CR3180	5F	3C	DS3376	9M	2E	R3350D	7J	2E	U3375	10L	3D
CR3181	6F	4D	DS3377	9N	2E	R3350E	10P	2E			
CR3182	6F	4B	DS3378	9N	2E	R3350F	7G	2E	W651	8S	3F
CR3183	6G	4C	DS3379	9N	3E	R3350G	7M	2E	W652	10A	2A
CR3184	6G	4B	DS3380	9P	3E				W652	3S	2A
CR3185	5C	4C	DS3390	7G	1E	S3000A	3J	2A			

Partial A6 also shown on diagram 12.

ASSEMBLY A7											
CIRCUIT NUMBER	SCHEM LOCATION	BOARD LOCATION	CIRCUIT NUMBER	SCHEM LOCATION	BOARD LOCATION	CIRCUIT NUMBER	SCHEM LOCATION	BOARD LOCATION	CIRCUIT NUMBER	SCHEM LOCATION	BOARD LOCATION
J671	7N	5D	R3420 R3430	7M 7M	6A 6B	R3475	8M	6C			

CHASSIS MOUNTED PARTS											
CIRCUIT NUMBER	SCHEM LOCATION	BOARD LOCATION	CIRCUIT NUMBER	SCHEM LOCATION	BOARD LOCATION	CIRCUIT NUMBER	SCHEM LOCATION	BOARD LOCATION	CIRCUIT NUMBER	SCHEM LOCATION	BOARD LOCATION
P601 P671	5D 7N	CHASSIS CHASSIS	S3185	5D	CHASSIS	W671	8N	CHASSIS			

ACRONYM DICTIONARY

The following listing explains some of the less obvious acronyms and signal labels used on this schematic. Acronyms and labels not shown in this listing may be included in the circuit descriptions (Section 3) and should be obvious if a little thought is given to the intended circuit function.

CH1 VAR . . . channel 1 variable
 CH2 VAR . . . channel 2 variable
 DAC MUX1 IN . . . DAC multiplexer 1 input
 HORIZ VAR . . . horizontal variable

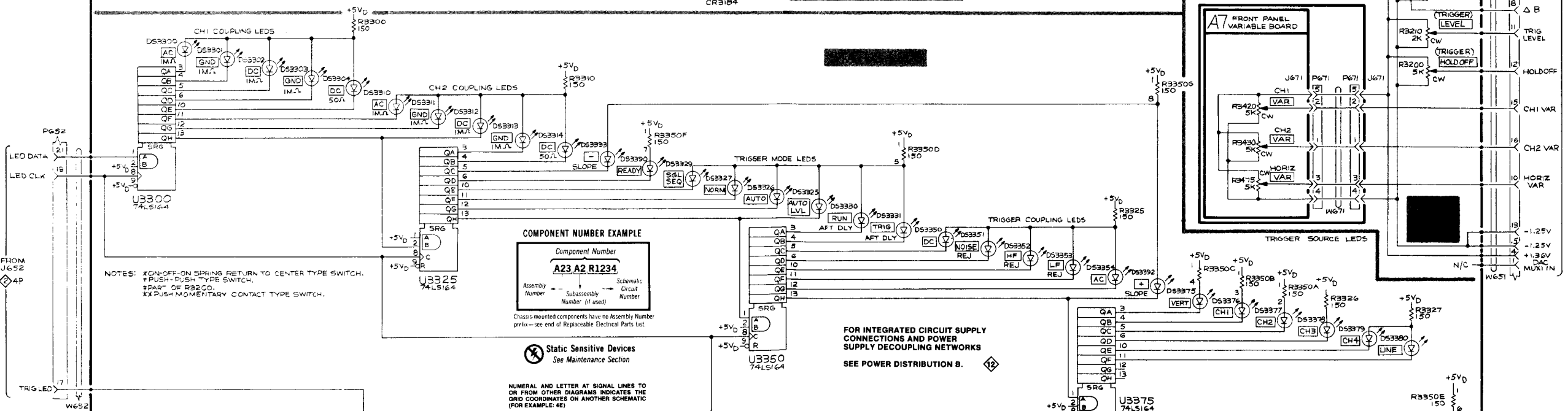
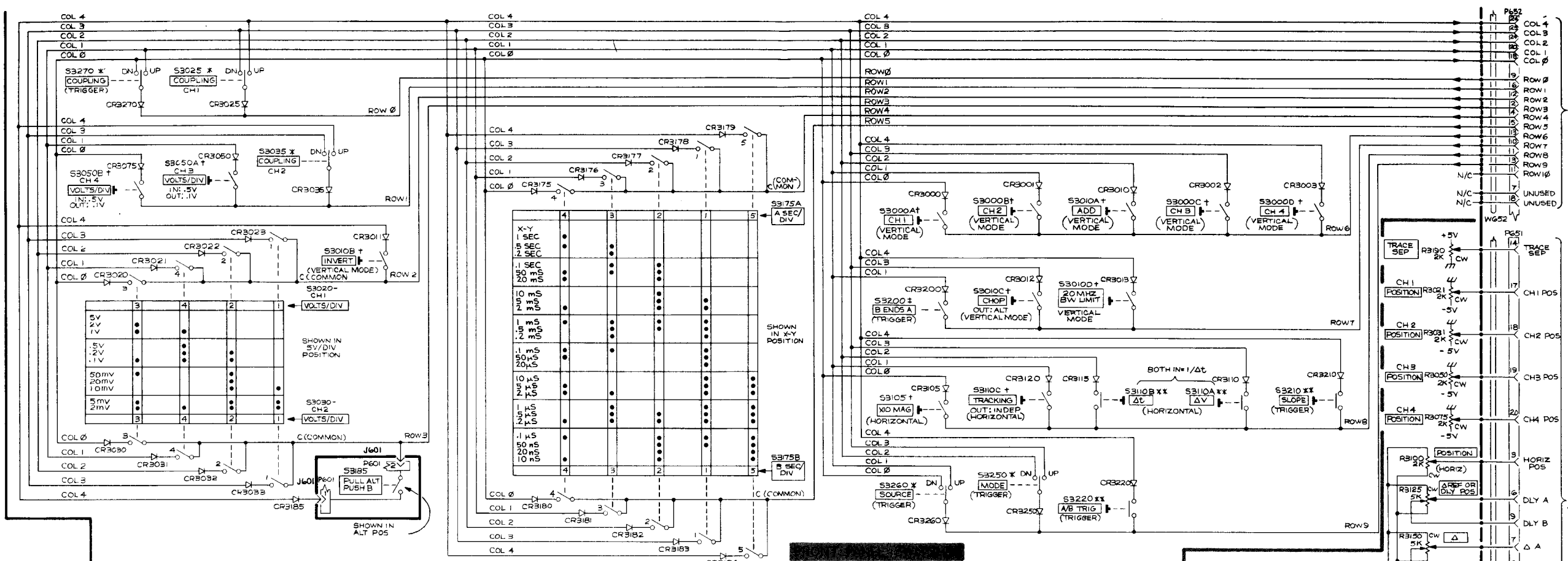

COMPONENT NUMBER EXAMPLE

Component Number
A23 A2 R1234

Assembly Number Schematic Number
 Subassembly Number (if used) Circuit Number

Chassis mounted components have no Assembly Number prefix - see end of Replaceable Electrical Parts List.

Static Sensitive Devices
 See Maintenance Section

FOR INTEGRATED CIRCUIT SUPPLY CONNECTIONS AND POWER SUPPLY DECOUPLING NETWORKS
 SEE POWER DISTRIBUTION B.

NOTES: *ON-OFF-ON SPRING RETURN TO CENTER TYPE SWITCH.
 †PUSH-PUSH TYPE SWITCH.
 ‡PART OF R3200.
 XX PUSH-MOMENTARY CONTACT TYPE SWITCH.

NUMERAL AND LETTER AT SIGNAL LINES TO OR FROM OTHER DIAGRAMS INDICATES THE GRID COORDINATES ON ANOTHER SCHEMATIC (FOR EXAMPLE: 4E)

TO FROM J652
 6B

TO FROM J651
 2B 8B 9B

-1.25V
 -1.25V
 +1.35V
 DAC
 MUX17N

G H J K L M N P

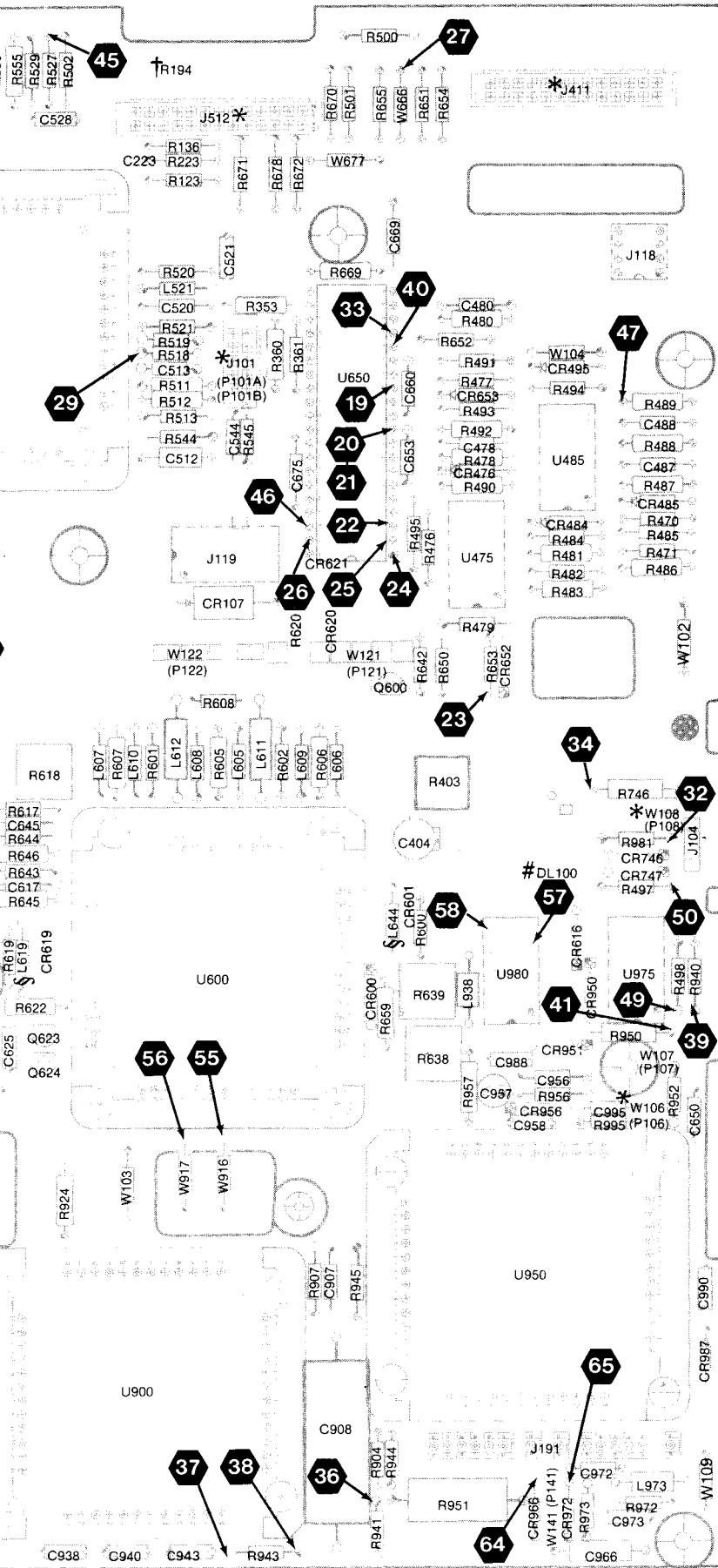

A8

ALL COMPONENTS MOUNTED ON A8—SCALE ILLUMINATION CIRCUIT BOARD ARE SHOWN ON SCHEMATIC DIAGRAM 4.

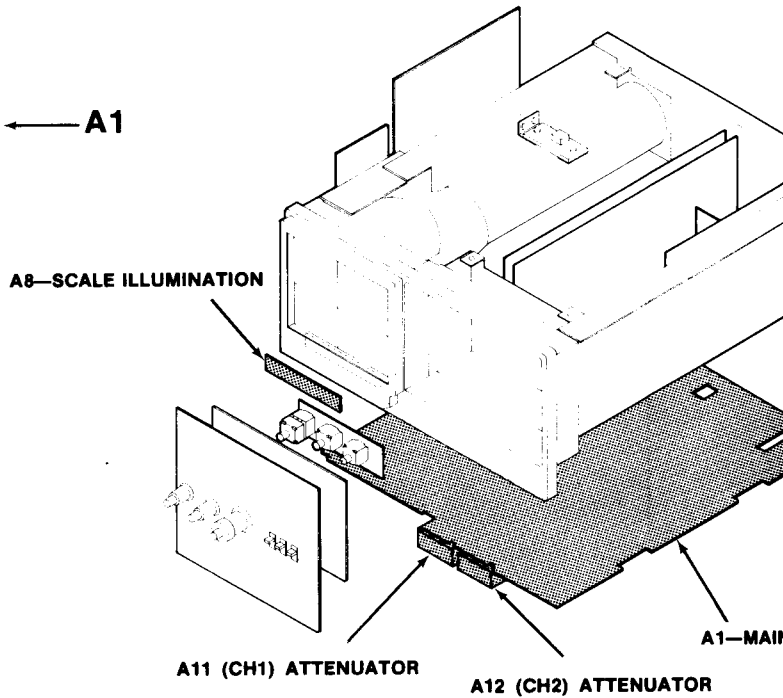

- () COMPONENTS WITHIN PARENTHESES MAY NOT BE LOCATED PRECISELY AS SHOWN BUT ARE NEAR THEIR INDICATED POSITION.
- † INDICATES COMPONENTS THAT WERE MANUALLY ADDED TO THE BOARD AS A RESULT OF MODIFICATION.
- * LABELED ON SOME BOARDS AS "P" VICE "J".
- # COMPONENT ON BACK OF BOARD.
- § USED FOR FUTURE TV OPTION.

⊗ Static Sensitive Devices
See Maintenance Section

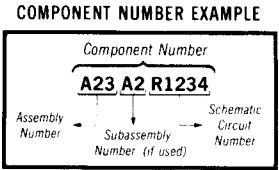

Chassis-mounted components have no Assembly Number prefix—see end of Replaceable Electrical Parts List

Figure 9-8. A1—Main and A8—Scale Illumination boards.